

**STATE MODEL SYLLABUS FOR
UNDER GRADUATE
COURSE IN SKILL ENHANCEMENT
COURSE (II)
(Bachelor of Arts/Sc/Com Examination)**

**UNDER
CHOICE BASED CREDIT SYSTEM**

FOREWARD

The Higher Education system has undergone a paradigm shift in Odisha with the introduction of Choice Based Credit System (CBCS) in the academic year 2015-16 as per the University Grant Commission regulations. Initially it was adopted in all Autonomous colleges and from 2016-17, in all the colleges of Odisha. CBCS offers students the liberty to choose from list of available courses under the domains of Ability Enhancement, Skill Enhancement and General Elective. This book on Quantitative and Logical Thinking aims to engage the students more creatively to improve their critical thinking skills. This paper will be taught under Skill Enhancement Compulsory Course (SECC).

The main intent of this paper is to strengthen the quantitative & logical thinking of Under Graduate students, majority of who are set to enter the job market with high hopes. Needless to say, a good command over Quantitative Aptitude and Logical Thinking is one skill which various companies expect from their prospective employees. The course content is developed with the help of faculties from Ravenshaw University, Rama Devi University and other experienced Mathematics faculties keeping in mind the diverse background of students of Odisha. We would like to acknowledge their vital contribution and members of the World Bank project in Higher Education for the development of this book. We hope the students find merit in using this book not just as a course study material but as a life time companion in improving his / her critical thinking skills. Any suggestions for improving the content are most welcome. The same can be emailed to oshec.hed@gmail.com

Bhubaneswar

Vice Chairperson
OSHEC

Table of Contents

I. QUANTITATIVE APTITUDE & DATA INTERPRETATION.....	4
Unit – 1: Whole numbers, Integers, Rational and irrational numbers, Fractions, Square roots and Cube roots, Surds and Indices, Problems on Numbers, Divisibility	4
Steps of Long Division Method for Finding Square Roots:	10
Unit -2: Basic concepts, Different formulae of Percentage, Profit and Loss, Discount, Simple interest, Ratio and Proportion, Mixture.....	14
Unit- 3: Time and Work, Pipes and Cisterns, Basic concepts of Time, Distance and Speed ; relationship among them	31
Unit – 4: Concept of Angles, Different Polygons like triangles, rectangle, square, right angled triangle, Pythagorean Theorem, Perimeter and Area of Triangles, Rectangles, Circles	41
Unit – 5: Raw and Grouped Data, Bar Graphs, Pie charts, Mean, Median and Mode, Events and Sample Space, Probability.....	53
II. LOGICAL REASONING.....	71
Unit - 1 : Analogy basing on kinds of relationships, Simple Analogy; Pattern and Series of Numbers, Letters, Figures. Coding-Decoding of Numbers, Letters, Symbols (Figures), Blood relations	71
UNIT – 2 : Logical Statements – Two premise argument, More than two premise argument using connectives	96
UNIT -3: Venn Diagrams, Mirror Images, Problems on Cubes and Dices.....	112

QUANTITATIVE AND LOGICAL THINKING

I. QUANTITATIVE APTITUDE & DATA INTERPRETATION

Unit – 1: Whole numbers, Integers, Rational and irrational numbers, Fractions, Square roots and Cube roots, Surds and Indices, Problems on Numbers, Divisibility

Definitions:

- Whole numbers:

All positive numbers including 0 are called whole numbers.

For Example - 0, 1, 2, 3 ...

- Prime numbers:

A number that is divisible only by itself and 1 is called a prime number.

For Example – 2, 3, 5, 7,

- ❖ Prime numbers are whole numbers.
- ❖ The smallest prime number is 2.

- Co-prime / Relatively prime/ Mutually prime:

Two numbers a and b (not both necessarily prime) are said to be co-prime, relatively prime or mutually prime if the only positive integer that divides both of them is 1.

For Example- 15 and 22 are co-prime because the only common divisor is 1.

- Integers:

All the positive and negative numbers including 0 are called integers.

For Example- -3, -2, -1, 0, 1, 2, 3 ...

- Rational numbers:

The set of numbers which can be written in the form of (p/q) are called rational numbers .

For Example - $115/4$, 0, $26/5$, $-22/9$...

- Irrational numbers:

The set of numbers which cannot be written in the form of (p/q) are called irrational numbers.

For Example - $\pi, \sqrt{2}, \sqrt[3]{3} \dots$

- Real numbers:

Real numbers contains the set of Whole numbers, integers, rational and irrational number.

For Example: 1, -2, 0, $\pi, \sqrt{2} \dots$

Basic formulae

1. $(a+b)^2 = a^2 + b^2 + 2ab$
2. $(a-b)^2 = a^2 + b^2 - 2ab$
3. $(a+b)^2 - (a-b)^2 = 4ab$
4. $(a+b)^2 + (a-b)^2 = 2(a^2 + b^2)$
5. $(a^2 - b^2) = (a+b)(a-b)$
6. $(a+b+c)^2 = a^2 + b^2 + c^2 + 2(ab+bc+ca)$
7. $(a^3 + b^3) = (a+b)(a^2 - ab + b^2)$
8. $(a^3 - b^3) = (a-b)(a^2 + ab + b^2)$
9. $(a^3 + b^3 + c^3 - 3abc) = (a+b+c)(a^2 + b^2 + c^2 - ab - bc - ca)$

Solved examples:

1. If one-third of one-fourth of a number is 15, then three-tenth of that number is:

Solution:

Let the number be x .

Then, $\frac{1}{3}$ of $\frac{1}{4}$ of $x = 15 \Leftrightarrow x = 15 \times 12 = 180$.

So, required number = $\left(\frac{3}{10} \times 180\right) = 54$.

2. The sum of two numbers is 25 and their difference is 13. Find their product.

Solution:

Let the numbers be x and y .

Then, $x + y = 25$ and $x - y = 13$.

$4xy = (x + y)^2 - (x - y)^2$

$$\begin{aligned}
&= (25)^2 - (13)^2 \\
&= (625 - 169) \\
&= 456 \\
\therefore xy &= 114.
\end{aligned}$$

3. The difference between a two-digit number and the number obtained by interchanging the positions of its digits is 36. What is the difference between the two digits of that number?

Solution:

Let the ten's digit be x and unit's digit be y .

Then, $(10x + y) - (10y + x) = 36$

$$\Rightarrow 9(x - y) = 36$$

$$\Rightarrow x - y = 4.$$

4. The difference between a two-digit number and the number obtained by interchanging the digits is 36. What are the digits of the number if the ratio between the digits of the number is 1 : 2 ?

Solution:

Since the number is greater than the number obtained on reversing the digits, so the ten's digit is greater than the unit's digit.

Let ten's and unit's digits be $2x$ and x respectively.

Then, $([10 \times 2x] + x) - (10x + 2x) = 36$

$$\Rightarrow 9x = 36$$

$$\Rightarrow x = 4.$$

$$\therefore \text{One digit is 4 and the other digit is } 2 \times 4 = 8$$

5. The product of two numbers is 18 and the sum of their squares is 45. The sum of the numbers is:

Solution:

Let the numbers be x and y .

Then, $xy = 18$ and $x^2 + y^2 = 45$.

$$\therefore (x + y)^2 = x^2 + y^2 + 2xy = 45 + (2 \times 18) = 81$$

$$\therefore x + y = \sqrt{81} = 9.$$

Divisibility rules

Divisibility by 2:

A number is divisible by 2 if the last digit is even. i.e., if the last digit is 0 or 2 or 4 or 6 or 8.

Ex: 454 is divisible by 2 , 455 is not divisible by 2.

Divisibility by 3:

A number is divisible by 3 if the sum of the digits is divisible by 3.

Ex: 459 is divisible by 3 as the sum of the digits, $4+5+9=18$ is divisible by 3.

Divisibility by 4:

A number is divisible by 4 if the number formed by the last two digits is divisible by 4.

Ex: 324 is divisible by 4 as 24 is divisible by 4.

Divisibility by 5:

A number is divisible by 5 if the last digit is either 0 or 5.

Ex: 555 is divisible by 5

Divisibility by 6:

A number is divisible by 6 if it is divisible by both 2 and 3.

Ex: 528 is divisible by 6 as 528 is divisible by both 2 & 3.

Divisibility by 8:

A number is divisible by 8 if the number formed by the last three digits is divisible by 8.

Ex: 8168 is divisible by 8 as 168 is divisible by 8.

Divisibility by 9:

A number is divisible by 9 if the sum of the digits is divisible by 9.

Ex: 981 is divisible by 9 as the number formed by the sum of the digits i.e. $18(9+8+1=18)$ is divisible by 9.

Divisibility by 10:

A number is divisible by 10 if the last digit is 0.

Ex: 100 is divisible by 10.

Divisibility by 11:

To find out if a number is divisible by 11, find the sum of the odd numbered digits and the sum of the even numbered digits.

Now subtract the lower number obtained from the bigger number obtained.

If the number we get is 0 or divisible by 11, the original number is also divisible by 11.

Ex: 121 is divisible by 11. (Sum of the digits in the even place is 2 & sum of the digits in the odd places is $1+1=2$. Now $2-2=0$ is divisible by 11.)

Solved examples:

1. Find the least value of * for which the number $8550*1$ is divisible by 3.

Solution:

Let the required number be a.

$$\text{Now } 8+5+5+0+a+1 = 19+a$$

Hence the least number is 2.

2. Find the least value of * for which the number $13*1$ is divisible by 11.

Solution:

Let the required number be x.

Now sum of digits at odd places – sum of digits at even places

$$= (1+3)-(1+x)$$

$$= (3-x), \text{ should be divisible by 11.}$$

Hence the least value of x is 3.

3. Is 7248 divisible (i) by 4, (ii) by 2 and (iii) by 8?

Solution:

(i) The number 7248 has 48 on its extreme right side which is exactly divisible by 4. When we divide 48 by 4 we get 12.

Therefore, 7248 is divisible by 4.

(ii) The number 7248 has 8 on its unit place which is an even number so, 7248 is divisible by 2.

(iii) 7248 is divisible by 8 as 7248 has 248 at its hundred place, tens place and unit place which is exactly divisible by 8.

4. A number is divisible by 4 and 12. Is it necessary that it will be divisible by 48? Give an example in support of you answer.

Solution:

$48 = 4 \times 12$ but 4 and 12 are not co-prime.

Therefore, it is not necessary that the number will be divisible by 48.

Let us consider the number 72 for an example

$72 \div 4 = 18$, so 72 is divisible by 4.

$72 \div 12 = 6$, so 72 is divisible by 12.

But 72 is not divisible by 48.

5. Without actual division, find if 235932 is divisible (i) by 4 and (ii) 8.

Solution:

(i)The number formed by the last two digits on the extreme right side of 235932 is 32

$32 \div 4 = 8$, i.e. 32 is divisible by 4.

Therefore, 235932 is divisible by 4.

(ii) The number formed by the last three digits on the extreme right side of 235932 is 932

But 932 is not divisible by 8. Therefore, 235932 is not divisible by 8.

Square roots

Steps of Long Division Method for Finding Square Roots:

Step I: Group the digits in pairs, starting with the digit in the units place.

Step II: Think of the largest number whose square is equal to or just less than the first group. Take this number as the divisor and also as the quotient.

Step III: Subtract the product of the divisor and the quotient from the first group and bring down the next group to the right of the remainder. This becomes the new dividend.

Step IV: Now, the new divisor is obtained by taking two times the quotient and annexing with it a suitable digit which is also taken as the next digit of the quotient, chosen in such a way that the product of the new divisor and this digit is equal to or just less than the new dividend.

Step V: Repeat steps (2), (3) and (4) till all the groups have been taken up. Now, the quotient so obtained is the required square root of the given number.

Solved examples:

1. Find out $\sqrt{16384}$.

Solution:

Marking group and using the long-division method,

$$\begin{array}{r|l} 1 & \overline{1} \quad \overline{63} \quad \overline{84} \quad (128 \\ & \underline{1} \\ 22 & \quad \underline{63} \\ & \quad \quad \underline{44} \\ 248 & \quad \quad \underline{1984} \\ & \quad \quad \quad \underline{1984} \\ & \quad \quad \quad \quad \underline{0} \end{array}$$

Therefore, $\sqrt{16384} = 128$.

2. Find out $\sqrt{66049}$.

Solution:

Marking group and using the long-division method,

$$\begin{array}{r} 2 \quad \overline{6 \quad 60 \quad 49} \quad (257 \\ \quad \underline{4} \\ 45 \quad \underline{260} \\ \quad \underline{225} \\ 507 \quad \underline{3549} \\ \quad \underline{3549} \\ \quad \quad \underline{0} \end{array}$$

Therefore, $\sqrt{66049} = 257$

Surds & Indices

Definitions:

- Index

An **index** (plural: **indices**) is the power, or exponent, of a number. E.g a^5 has an **index** of 5.

- Surd

A **surd** is an irrational number that can be expressed with roots.

E.g. Let a be rational number and n be a positive integer such that $(a)^{(1/n)} = \sqrt[n]{a}$, Then a is called a surd of order n .

Laws of Indices:

1. $a^m \times a^n = a^{m+n}$
2. $(a^m)^n = a^{mn}$
3. $(ab)^n = a^n b^n$

$$4. \frac{a^m}{a^n} = a^{m-n}$$

$$5. a^0 = 1$$

$$6. \left(\frac{a}{b}\right)^n = \frac{a^n}{b^n}$$

$$7. a^{-n} = \frac{1}{a^n}$$

Laws of Surds:

$$1. \sqrt[n]{a} = a^{(1/n)}$$

$$2. \sqrt[m]{\sqrt[n]{a}} = \sqrt[mn]{a}$$

$$3. \sqrt[n]{\frac{a}{b}} = \left(\frac{a}{b}\right)^{\frac{1}{n}}$$

Solved examples:

1. Divide 12 by $3\sqrt{2}$.

Solution:

$$\frac{12}{3\sqrt{2}} = \frac{4}{\sqrt{2}} = \frac{4 \times \sqrt{2}}{\sqrt{2} \times \sqrt{2}} = 2\sqrt{2}.$$

2. Simplify $(125)^{-2/3}$.

Solution:

$$\begin{aligned} (125)^{-2/3} &= (5 \times 5 \times 5)^{-2/3} = (5)^{3 \times \frac{-2}{3}} \\ &= 5^{-2} = \frac{1}{5^2} \\ &= \frac{1}{25} \end{aligned}$$

3. $15^4 \times 15^x = 15^6$ Find the value of x.

Solution:

$$15^4 \times 15^x = 15^6$$

$$\Rightarrow 15^x = \frac{15^6}{15^4}$$

$$\Rightarrow 15^x = 15^2$$

$$\Rightarrow x = 2$$

4. If $2^a = 64$, then find the value of 2^{a-3} .

Solution:

We have $2^a = 64$ (Since the LHS contains a power of 2 so the RHS must be expressed in terms of some power of 2)

$$\Rightarrow 2^a = 2^6$$

$$\Rightarrow a = 6$$

$$\therefore 2^{a-3} = 2^{6-3} = 2^3 = 8.$$

Unit -2: Basic concepts, Different formulae of Percentage, Profit and Loss, Discount, Simple interest, Ratio and Proportion, Mixture

Definitions:

Percentage is a fraction whose denominator is always 100. x percentage is represented by

$$x \% = \frac{x}{100}$$

Example - $25 \% = \frac{25}{100} = \frac{1}{4}$

Formulae:

1. To express $\frac{x}{y}$ as a percentage

We know that $\frac{x}{y} = \left(\frac{x}{y} \times 100\right) \%$

E.g.- $\frac{1}{4} = \left(\frac{1}{4} \times 100\right) \% = 25\%$

2. If A is R % more than B, then B is less than A by $\left(\frac{R}{R+100} \times 100\right) \%$.
3. If A is R % less than B, then B is more than A by $\left(\frac{R}{100-R} \times 100\right) \%$.
4. If the price of a commodity increases by R %, then reduction in consumption as not to increase the expenditure is $\left(\frac{R}{R+100} \times 100\right) \%$.
5. If the price of a commodity decreases by R %, then increase in consumption as not to decrease the expenditure is $\left(\frac{R}{100-R} \times 100\right) \%$.
6. Results on Population : Let the population of a town be P now and suppose increases at the rate of R % per annum, then :
 - i) Population after n years = $P \left(1 + \frac{R}{100}\right)^n$.

$$\text{ii) Population } n \text{ years ago} = \frac{P}{\left(1 + \frac{R}{100}\right)^n}$$

7. Results on Depreciation: Let the present value of a machine be P . Suppose it depreciates at the rate of R % per annum , then :

$$\text{i) Value of machine after } n \text{ years} = P \left(1 - \frac{R}{100}\right)^n$$

$$\text{ii) Value of machine } n \text{ years ago} = \frac{P}{\left(1 - \frac{R}{100}\right)^n}$$

8. To remember :

$$\frac{1}{2} = 50 \%$$

$$\frac{1}{4} = 25 \%$$

$$\frac{1}{6} = 16 \frac{2}{3} \%$$

$$\frac{1}{8} = 12 \frac{1}{2} \%$$

$$\frac{1}{10} = 10 \%$$

$$\frac{1}{12} = 8 \frac{1}{3} \%$$

$$\frac{1}{3} = 33 \frac{1}{3} \%$$

$$\frac{1}{5} = 20 \%$$

$$\frac{1}{7} = 14 \frac{2}{7} \%$$

$$\frac{1}{9} = 11 \frac{1}{9} \%$$

$$\frac{1}{11} = 9 \frac{1}{11} \%$$

$$\frac{1}{13} = 7 \frac{6}{13} \%$$

Solved examples:

1. Find 8 % of 625.

$$\text{Solution : } \frac{8}{100} \times 625 = 50.$$

2. Ram's salary is increased from Rs. 24,000 to Rs. 30,000. Find the increased % .

Solution :

$$\text{Increase in salary} = \text{Rs.}30,000 - \text{Rs.}24,000 = \text{Rs.} 6000$$

$$\% \text{ Increase} = \frac{6000}{24000} \times 100 = 25 \%$$

3. In an election, candidate A got 75% of the total valid votes. If 15% of the total votes were declared invalid and the total numbers of votes is 560000, find the number of valid vote polled in favor of candidate.

Solution:

Given that 15% of the total votes were invalid. So we have,

Total number of valid votes = 85 % of 560000

$$\begin{aligned} &= \frac{85}{100} \times 560000 \\ &= \frac{47600000}{100} \\ &= 476000 \end{aligned}$$

Percentage of votes polled in favor of candidate A = 75 %

Therefore, the number of valid votes polled in favors of candidate A = 75 % of 476000

$$\begin{aligned} &= \frac{75}{100} \times 476000 \\ &= \frac{35700000}{100} \\ &= 357000 \end{aligned}$$

4. Rama had Rs.2100 left after spending 30 % of the money he took for shopping. How much money did he take along with him?

Solution:

Let the money Rama took along with him be 100%.

Given that he spent 30 % of the money for shopping. So money left with him is 70% of the money.

But money left with him = Rs. 2100

Therefore 70%= Rs. 2100

$$\Rightarrow 100\% = \text{Rs } 2100 \times \frac{100}{70}$$

$$\Rightarrow 100\% = \text{Rs } 3000$$

Therefore, the money he took for shopping is Rs 3000.

5. A shopkeeper bought 600 oranges and 400 bananas. He found 15% of oranges and 8% of bananas were rotten. Find the percentage of fruits in good condition.

Solution:

Total number of fruits shopkeeper bought = $600 + 400 = 1000$

Given that 15% of oranges and 8% of bananas were rotten. So he had 85% of oranges & 92 % of bananas in good condition.

Number of oranges in good condition = 85% of 600

$$\begin{aligned} &= \frac{85}{100} \times 600 \\ &= 510 \end{aligned}$$

Number of bananas in good condition = 92 % of 400

$$\begin{aligned} &= \frac{92}{100} \times 400 \\ &= 368 \end{aligned}$$

Therefore Number of fruits in good condition = $510 + 368 = 878$

Therefore Percentage of fruits in good condition = $\left(\frac{878}{1000} \times 100\right)\%$
 $= 87.8\%$

PROFIT & LOSS

Definitions:

- Cost Price: The price at which an article is purchased is called its cost price and it is denoted by CP.
- Selling Price: The price at which an article is sold is called its selling price and denoted by SP.
- Profit (P) :If SP is greater than CP, then seller is said to have a profit.
- Loss (L) : If SP is less than CP , then seller is said to have a loss.
- Marked price: MRP of an article is known as marked price or labeled price and denoted by MP.
- Discount : Discount is a percentage of the MP.

* Profit and loss are always counted on CP.

* Discount is always carried on MP.

Formulae:

1. $P = SP - CP$

2. $L = CP - SP$

3. $P \% = \frac{P}{CP} \times 100$

4. $L \% = \frac{L}{CP} \times 100$

5. $SP = \frac{100+P \%}{100} \times CP$

6. $SP = \frac{100-L \%}{100} \times CP$

7. $CP = \frac{100}{100+P \%} \times SP$

8. $CP = \frac{100}{100-L \%} \times SP$

9. Discount (D) = MP - SP

10. Discount % = $\frac{\text{Discount}}{MP} \times 100$

11. $SP = \frac{100-D \%}{100} \times MP$

Solved examples:

1. A person purchased an article for Rs. 80 and sold it for Rs.120. Find his % of profit.

Solution :

CP of the article = Rs. 80

SP of the article = Rs. 120

Profit = SP - CP

$$= \text{Rs. } 120 - \text{Rs. } 80 = \text{Rs. } 40$$

$$\text{Profit \%} = \frac{40}{80} \times 100 = 50 \%$$

2. By selling a fan for Rs 649, Anil earns a profit of 18%. Find its cost price.

Solution:

S.P. of the fan = Rs 649, profit = 18%

Therefore, Rs 649 = $(1 + \frac{18}{100})$ of C.P.

$$\Rightarrow \text{Rs } 649 = \frac{118}{100} \text{ of C.P.}$$

$$\Rightarrow \text{C.P.} = \text{Rs } (649 \times \frac{100}{118}) = \text{Rs } 550$$

Hence the cost price of the fan = Rs 550.

3. Sammy sold his dining table set at a loss of 20%. If he had sold it for Rs. 800 more, he would have received a profit of 5%. Find the cost price.

Solution :

Let the cost price be Rs. 100

So when C.P = 100 , loss of 20% means

$$\text{S.P} = 100 - 20 = 80$$

Profit of 5% means S.P = 100 + 5 = 105

The difference of two S.P = 105 - 80 = 25

If the difference is 25, C.P = Rs100

If the difference is Rs 800 , C.P = $(100 / 25) \times 800$

$$\text{C.P} = \text{Rs } 3200$$

4. The cost of 11 pencils is equal to the selling price of 10 pencils. Find the loss or profit percent, whatever may be the cost of 1 pencil.

Solution:

The cost price of 11 pencils = S.P of 10 pencils

Let C.P of 1 pencil is Rs.1.

C.P of 10 pencils = Rs. 10

S.P of 10 pencils = C.P of 11 pencils = Rs. 11

Profit on 10 pencils = 11 - 10 = Rs. 1

$$\text{Profit \%} = \left(\frac{1}{10}\right) \times 100 = 10 \%$$

5. A person sold an article at a profit of 12 %. If he had sold it Rs. 4 more, he would have gained 20 %. What is the cost price?

Solution:

Let the CP of an article be Rs x. Then,

$$112 \% \text{ of } x + 4 = 120 \% \text{ of } x$$

$$\Rightarrow 120 \% \text{ of } x - 112 \% \text{ of } x = 4$$

$$\Rightarrow 8 \% \text{ of } x = 4$$

$$\Rightarrow \frac{8}{100} \times x = 4$$

$$\Rightarrow x = 4 \times \frac{100}{8} = 50.$$

DISCOUNT

Solved examples:

1. If the Marked Price of an article is Rs 1000, then what is the Selling Price at a discount rate of 20%?

Solution:

Given MP of an article = Rs. 1000

$$D\% = 20$$

$$\text{So SP} = 1000 \times \frac{80}{100} = 800.$$

2. Find the selling price of an article after two successive discount 10% & 20% if the marked price is Rs. 2500.

Solution:

Given MP of an article = Rs. 2500

$$SP = \frac{100 - D \%}{100} \times MP$$

So after first discount 10%, $SP = \frac{100-10}{100} \times 2500 = Rs. 2250$

Now the new MP is = Rs. 2250

After 20% successive discount $SP = \frac{100-20}{100} \times 2250 = Rs. 1800$

3. If the marked price of an article is 13% more than CP and a shopkeeper allows a discount of 10%. Find the profit/ loss percentage?

Solution:

Let CP of the article be Rs. 100.

Then MP = 113% of 100 = 113

Discount = 10%

$$SP = 113 \times \frac{90}{100}$$

$$= 101.7$$

$$P = SP - CP = 101.7 - 100 = 1.7$$

$$\% P = \frac{P}{CP} \times 100 = \frac{1.7}{100} \times 100 = 1.7 \%$$

4. After getting two successive discounts, a shirt with MRP Rs. 500 is available at Rs.420. If the first discount is 12.5% then find out the percentage of second discount.

Solution:

Let the second discount be x %.

Thus, $(100 - x) \%$ of 87.5% of 500 = 420

$$\Rightarrow \frac{100-x}{100} \times \frac{87.5}{100} \times 500 = 420$$

$$\Rightarrow 100 - x = 96$$

$$\Rightarrow x = 4 \%$$

5. At what % above the CP must an article be marked so as to gain 17 % allowing 10 % discount?

Solution:

Let CP of the article be 100.

Then SP = 117

Let MP of the article be x. Now,

90 % of x = 117

$$\Rightarrow \frac{90}{100} \times x = 117$$

$$\Rightarrow x = 117 \times \frac{100}{90} = 130.$$

So, MP = 30 % above CP.

SIMPLE INTEREST

Definition :

- Principal (P): The money borrowed or lent out for a certain period is called principal.
- Interest (I): Extra money paid for using other 's money is called interest.
- Simple Interest (S.I) : If the interest on the money borrowed is paid uniformly , then it is called simple interest.

Formulae :

1. $S.I = \frac{P \times R \times T}{100}$

Where , P = principal

R = rate percent per annum

T = time period (Number of years)

2. Amount (A) = P + S.I

Conversions

1. Case I : If S.I , R and T are known ,

$$P = \frac{S.I \times 100}{R \times T}$$

2. Case II : If S.I , P and T are known ,

$$R = \frac{S.I \times 100}{P \times T}$$

3. Case III : If S.I , P and R are known ,

$$T = \frac{S.I \times 100}{P \times R}$$

Solved examples:

1. Find S.I on Rs 2000 at the rate of interest 10 % p.a. for 2 years .

Solution:

$$\begin{aligned} S.I &= \frac{P \times R \times T}{100} \\ &= \frac{2000 \times 10 \times 2}{100} \\ &= \text{Rs. } 400 \end{aligned}$$

2. Find S.I and the amount on Rs. 4000 at a rate of interest 5 % for 6 months.

Solution:

Here, P = Rs. 4000 , R = 5 % , T = 6 months = $\frac{6}{12}$ years = $\frac{1}{2}$ year

$$\begin{aligned} S.I &= \frac{P \times R \times T}{100} \\ &= \frac{4000 \times 5 \times 1}{100 \times 2} = \text{Rs. } 100 \end{aligned}$$

$$\text{Amount} = P + S.I$$

$$= \text{Rs. } 4000 + \text{Rs. } 100 = \text{Rs. } 4100$$

3. In what time will Rs. 3100 amount to Rs. 6200 at 4 % p.a ?

Solution :

Here , $P = \text{Rs. } 3100$, $R = 4\%$, $A = \text{Rs. } 6200$

So, Interest = Rs. $6200 - \text{Rs. } 3100 = \text{Rs. } 3100$

$$T = \frac{3100 \times 100}{3100 \times 4} = 25 \text{ years}$$

4. A sum of money put at S.I doubles itself in 8 years . In how many years it will become five times ?

Solution :

Let Principal be P . Then, Amount = $2P$

$$\Rightarrow \text{S.I} = 2P - P = P$$

$$\text{Using, S.I} = \frac{P \times R \times T}{100}$$

$$\Rightarrow P = \frac{P \times R \times 8}{100}$$

$$\Rightarrow R = \frac{100}{8}$$

Again Principal = P

$$\Rightarrow \text{Amount} = 5P$$

$$\Rightarrow \text{S.I} = 5P - P = 4P$$

$$\text{Again using, S.I} = \frac{P \times R \times T}{100}$$

$$\Rightarrow 4P = \frac{P \times \frac{100}{8} \times T}{100}$$

$$\Rightarrow T = 4 \times 8 = 32 \text{ years.}$$

5. If S.I is $\frac{1}{4}$ th of the principal and the number of years is equal to rate of interest , then find the rate percent p.a.?

Solution :

Let Principal = P

$$\Rightarrow \text{S.I} = \frac{1}{4} P$$

Let Rate of interest be x .

As per the question, Time = rate of interest = x .

$$S.I = \frac{P \times R \times T}{100}$$

$$\Rightarrow \frac{1}{4} P = \frac{P \times x \times x}{100}$$

$$\Rightarrow x^2 = \frac{100}{4} = 25$$

$$\Rightarrow x = 5$$

RATIO AND PROPORTION

Definition:

- **Ratio:** The ratio of two quantities a and b in the same units is the fraction $\frac{a}{b}$ and we write it as $a : b$. In the ratio $a : b$, a is the first term or antecedent and b is the second term or consequent.

Example - In the ratio $5 : 9$, 5 is the antecedent and 9 is the consequent.

- **Proportion:** The equality of two ratios is called proportion.

If $a : b = c : d$, then **a**, **b**, **c** and **d** are in proportion and can also be written as $a : b :: c : d$

Solved examples:

1. Divide 240 into two parts in the ratio $2 : 3$.

Solution –

Let the first part be $2x$ and the second part be $3x$.

Now, $2x + 3x = 240$

$$\Rightarrow 5x = 240$$

$$\Rightarrow x = 48$$

So $2x = 2 \times 48 = 96$ and $3x = 3 \times 48 = 144$.

2. Find three numbers in the ratio 1 : 3 : 5 so that the sum of their squares is equal to 315.

Solution –

Let the numbers be x , $3x$, $5x$.

Now, we have

$$x^2 + (3x)^2 + (5x)^2 = 315$$

$$\Rightarrow x^2 + 9x^2 + 25x^2 = 315$$

$$\Rightarrow 35x^2 = 315$$

$$\Rightarrow x^2 = 9$$

$$\Rightarrow x = 3$$

$$\Rightarrow 3x = 9 \text{ \& } 5x = 15$$

∴ The required numbers are 3, 9 and 15.

3. A mixture contains milk and water in the ratio 5 : 4. If 5 litres of water is added to the mixture, the ratio becomes 5 : 6. Find the quantity of milk in the given mixture.

Solution –

Let the quantity of milk and water be $5x$ and $4x$ litres respectively. Then, $\frac{5x}{4x+5} = \frac{5}{6}$

$$\Rightarrow 30x = 20x + 25$$

$$\Rightarrow 10x = 25$$

$$\Rightarrow x = 2.5 \text{ litres}$$

$$\Rightarrow 5x = 5 \times 2.5 = 12.5 \text{ litres}$$

Thus, the quantity of milk in the given mixture is 12.5 litres.

4. The sides of a triangle are in the ratio $\frac{1}{2} : \frac{1}{3} : \frac{1}{4}$ and its perimeter is 78 cm. Find the length of the sides of the triangle.

Solution –

Let the sides of the triangle be $a = \frac{1}{2}x$, $b = \frac{1}{3}x$, $c = \frac{1}{4}x$

Given, Perimeter of the triangle is 78 cm.

$$\Rightarrow \frac{1}{2}x + \frac{1}{3}x + \frac{1}{4}x = 78$$

$$\Rightarrow \frac{13}{12}x = 78$$

$$\Rightarrow x = 72 \text{ cm}$$

$$\Rightarrow a = 36 \text{ cm}, b = 24 \text{ cm and } c = 18 \text{ cm}.$$

MIXTURE & ALLIGATION

Definition:

- **Alligation:** It is a rule that enables us to find the ratio in which two or more ingredients at the given price must be mixed to produce a mixture of desired price.
- **CP of the mixture:** It is the cost price of a unit quantity of mixture.
- It is a modified form of finding the weighted average. If 2 ingredients are mixed in a ratio and the cost price of the unit quantity of the mixture, called the cost of mixture per kg is given then,
$$\Rightarrow Q_c \times (m - c) = Q_d \times (d - m)$$
- Here 'd' is the cost of dearer ingredient, 'm' is the cost of mixture per kg and 'c' is the cost of cheaper ingredient. Q_c & Q_d are the quantity of the cheaper and dearer ingredient respectively.

Solved examples:

1. The cost of Type 1 material is Rs. 15 per kg and Type 2 material is Rs.20 per kg. If both Type 1 and Type 2 are mixed in the ratio of 2 : 3, then what is the price per kg of the mixed variety of material?

Solution –

Cost Price (CP) of Type 1 material is Rs. 15 per kg
Cost Price (CP) of Type 2 material is Rs. 20 per kg

Type 1 and Type 2 are mixed in the ratio of 2 : 3.

Hence Cost Price (CP) of the resultant mixture

$$= \frac{(15 \times 2) + (20 \times 3)}{(2 + 3)} = \frac{90}{5} = 18$$

Price per kg of the mixed variety of material = Rs.18.

2. A mixture of 30 litres of milk and water contains 30% of water. The new mixture is formed by adding 10 lit of water. What is the percentage of water in the new mixture?

Solution -

Quantity of water in the 30 litre mixture = $\frac{30}{100} \times 30 = 9$ litre

After adding 10 litre of water, quantity of water becomes 19 litre and total quantity becomes 40 litre.

Percentage of water = $\frac{19}{40} \times 100 = 47.5\%$

3. Tea worth of Rs. 135/kg & Rs. 126/kg are mixed with a third variety in the ratio 1: 1 : 2. If the mixture is worth Rs. 153 per kg, the price of the third variety per kg will be ?

Solution –

Let the price of the third variety of tea be Rs. x.

Given that Tea worth of Rs. 135/kg , Rs. 126/kg &Rs. x/kg are mixed in the ratio 1: 1 : 2 and the mixture is worth Rs. 153 per kg

Now we have, $\frac{135 \times 1 + 126 \times 1 + x \times 2}{1 + 1 + 2} = 153$

$$\Rightarrow \frac{135 + 126 + 2x}{4} = 153$$

$$\Rightarrow 261 + 2x = 153 \times 4 = 612$$

$$\Rightarrow 2x = 612 - 261 = 351$$

$$\Rightarrow x = 175.50$$

Hence, price of the third variety = Rs.175.50 per kg.

4. A merchant has 1000 kg of sugar part of which he sells at 8% profit and the rest at 18% profit. He gains 14% on the whole. The Quantity sold at 18% profit is?

Solution –

By the rule of alligation:

$$Q_c \times (m - c) = Q_d \times (d - m)$$

$$\Rightarrow \frac{Q_c}{Q_d} = \frac{(d - m)}{(m - c)} = \frac{18 - 14}{14 - 8} = \frac{4}{6} = \frac{2}{3}$$

So, ratio of cheaper quantity and dearer quantity = 2 : 3

∴ Quantity of dearer part = $\frac{3}{5} \times 1000 = 600$ Kg

5. A mixture of 150 litres of wine and water contains 20% water. How much more water should be added so that water becomes 25% of the new mixture?

Solution –

Number of litres of water in 150 litres of the mixture = 20% of 150 = $\frac{20}{100} \times 150 = 30$ litres

Let us assume that another 'P' litre of water is added to the mixture to make water 25% of the new mixture. So, the total amount of water becomes (30 + P) and the total volume of the mixture becomes (150 + P)

Thus, (30 + P) = 25% of (150 + P)

$$\Rightarrow 30 + P = \frac{25}{100} \times (150 + P)$$

$$\Rightarrow 30 + P = \frac{(150 + P)}{4}$$

$$\Rightarrow 120 + 4P = 150 + P$$

$$\Rightarrow 4P - P = 30$$

$$\Rightarrow 3P = 30$$

∴ We get $P = 10$ litres.

Unit- 3: Time and Work, Pipes and Cisterns, Basic concepts of Time, Distance and Speed ; relationship among them

- Work done is dependent on factors like number of persons working, number of days, number of hours working per day etc., If M_1 persons working D_1 days can complete W_1 amount of work and M_2 persons working D_2 days can complete W_2 amount of work, then we have a general formula in the relationship of

$$\frac{M_1 D_1}{W_1} = \frac{M_2 D_2}{W_2}$$

$$\Rightarrow M_1 D_1 W_2 = M_2 D_2 W_1$$

- If we include the working hours (say, T_1 and T_2) for the two groups and efficiency (say, E_1 and E_2) of the persons in two groups, then the relationship is

$$\frac{M_1 D_1 T_1 E_1}{W_1} = \frac{M_2 D_2 T_2 E_2}{W_2}$$

$$\Rightarrow M_1 D_1 W_2 T_1 E_1 = M_2 D_2 W_1 T_2 E_2$$

Important Formulae

1. Work from days

If A can do a piece of work in n days, then A's 1 day's work = $\frac{1}{n}$

2. Days from Work

If A's 1 day's work = $\frac{1}{n}$, then A can finish the work in n days.

3. Ratio

- a) If A is thrice as good a workman as B, then ,
- Ratio of work done by A and B =3:1.
 - Ratio of times taken by A and B to finish a work =1:3
- b) If A is x times as good a workman as B, then he will take $(\frac{1}{x})^{th}$ of the time by B to do the same work.
1. A and B can do a piece of work in 'x' days and 'y' days respectively, then working together, they will take $(\frac{xy}{x+y})$ days to finish the work and in one day, they will finish $(\frac{x+y}{xy})^{th}$ part of work.

Solved examples:

1. A can do piece of work in 30 days while B alone can do it in 40 days. In how many days can A and B working together do it?

Solution –

$$\text{A's one day's work} = \frac{1}{30}$$

$$\text{B's one day's work} = \frac{1}{40}$$

$$\text{(A+B)'s one day's work} = \frac{1}{30} + \frac{1}{40} = \frac{4+3}{120} = \frac{7}{120}$$

$$\therefore \text{Number of days required for A and B to finish the work} = \frac{1}{\frac{7}{120}} = \frac{120}{7} = 17\frac{1}{7} \text{ days.}$$

This can also be calculated by using the formula as...

2. To complete a piece of work A and B take 8 days, B and C 12 days. A, B and C take 6 days. A and C will take :

Solution –

$$\text{Given (A+B)'s one day's work} = \frac{1}{8}$$

$$\text{(B+C)'s one day's work} = \frac{1}{12}$$

$$(A+B+C)\text{'s 1 day's work} = \frac{1}{6}$$

$$\text{Work done by A, alone} = (A+B+C)\text{'s 1 day's work} - (B+C)\text{'s one day's work}$$

$$= \frac{1}{6} - \frac{1}{12}$$

$$= \frac{1}{12}$$

$$\text{Work done by C, alone} = (A+B+C)\text{'s 1 day's work} - (A+B)\text{'s one day's work}$$

$$= \frac{1}{6} - \frac{1}{8}$$

$$= \frac{1}{24}$$

$$(A+C)\text{'s one day's work} = \frac{1}{12} + \frac{1}{24} = \frac{1}{8}$$

∴ (A+C) will take 8 days to complete the work together.

3. A and B can do a piece of work in 45 days and 40 days respectively. They began to do the work together but A leaves after some days and then B completed the remaining work in another 23 days. The number of days after which A left the work was?

Solution –

$$(A+B)\text{'s 1 day's work} = \frac{1}{45} + \frac{1}{40} = \frac{17}{360}$$

$$\text{Work done by B in 23 days} = 1 \times \frac{23}{40} = \frac{23}{40}$$

$$\text{Remaining work} = 1 - \frac{23}{40} = \frac{17}{40}$$

Now, $\frac{17}{360}$ work was done by (A+B) in 1 day.

$$\frac{17}{40} \text{ Work was done by (A+B) in } 1 \times \frac{360}{17} \times \frac{17}{40} = 9 \text{ days}$$

∴ A left after 9 days.

4. A and B undertake to do a piece of work for Rs 600. A alone can do it in 6 days while B alone can do it in 8 days. With the help of C, they can finish it in 3 days, Find the share of C in Rs?

Solution –

$$\text{A's one day's work} = \frac{1}{6}$$

$$\text{B's one day's work} = \frac{1}{8}$$

$$\text{(A + B + C)'s one day's work} = \frac{1}{3}$$

$$\begin{aligned}\Rightarrow \text{C's one day's work,} &= \left(\frac{1}{3}\right) - \left(\frac{1}{6} + \frac{1}{8}\right) \\ &= \frac{1}{24}\end{aligned}$$

Therefore, A : B : C = Ratio of their one day's work

$$= \frac{1}{6} : \frac{1}{8} : \frac{1}{24}$$

$$\text{C's share for 3 days} = \frac{1}{24} \times 3 \times 600 = \text{Rs. } 75$$

5. A can build up a structure in 8 days and B can break it in 3 days. A has worked for 4 days and then B joined to work with A for another 2 days only. In how many days will A alone build up the remaining part of the structure?

Solution –

A can build the structure in 8 days.

$$\text{Fraction of structure built in a day by A} = \frac{1}{8}$$

$$\text{Similarly, fraction of structure broken by B in a day} = \frac{1}{3}$$

$$\text{Amount of work done by A in 4 days} = \frac{4}{8} = \frac{1}{2}$$

Now, both A and B together for 2 days.

$$\text{Amount of work done by A in 2 days} = \frac{2}{8} = \frac{1}{4}$$

$$\text{Amount of structure broken by B in 2 days} = \frac{2}{3}$$

$$\text{Fraction of structure built} = \left(\frac{1}{2} + \frac{1}{4}\right) - \frac{2}{3} = \frac{1}{12}$$

$$\text{Fraction of structure still to be built} = 1 - \frac{1}{12} = \frac{11}{12}$$

$$\text{If A takes } x \text{ days to build up the remaining structure, then } \frac{x}{8} = \frac{11}{12}$$

$$\Rightarrow x = 22/3 \text{ days.}$$

PIPES AND CISTERN

A pipe is connected to a tank or cistern. It is used to fill or empty the tank; accordingly, it is called an inlet or an outlet.

- Inlet pipe: A pipe which is connected to fill a tank is known as an inlet pipe.
- Outlet pipe: A pipe which is connected to empty a tank is known as an outlet pipe.

Important Formulae

1. If an inlet connected to a tank fills it in x hours, part of the tank filled in one hour is $= \frac{1}{x}$
2. If an outlet connected to a tank empties it in y hours, part of the tank emptied in one hour is $= \frac{1}{y}$
3. An inlet can fill a tank in x hours and an outlet can empty the same tank in y hours. If both the pipes are opened at the same time and $y > x$, the net part of the tank filled in one hour is given by;

$$= \left(\frac{1}{x} - \frac{1}{y} \right)$$

4. An inlet can fill a tank in x hours and another inlet can fill the same tank in y hours. If both the inlets are opened at the same time, the net part of the tank filled in one hour is given by;

$$= \left(\frac{1}{x} + \frac{1}{y} \right)$$

Solved examples:

1. Two pipes A and B can fill a tank in 12 and 24 minutes respectively. If both the pipes are used together, then how long will it take to fill the tank?

Solution –

$$\text{Part filled by pipe A in 1 minute} = \frac{1}{12}$$

$$\text{Part filled by pipe B in 1 minute} = \frac{1}{24}$$

Part filled by pipe A and pipe B in 1 minute

$$= \frac{1}{12} + \frac{1}{24} = \frac{1}{8}$$

- ∴ Both the pipe together can fill the tank in 8 minutes.
2. Pipes A and B can fill a tank in 5 and 6 hours respectively. Pipe C can empty it in 12 hours. If all the three pipes are opened together, then the tank will be filled in:

Solution –

Pipes A and B can fill the tank in 5 and 6 hours respectively. Therefore,
part filled by pipe A in 1 hour = $\frac{1}{5}$
part filled by pipe B in 1 hour = $\frac{1}{6}$

Pipe C can empty the tank in 12 hours. Therefore,
part emptied by pipe C in 1 hour = $\frac{1}{12}$

Net part filled by Pipes A,B,C together in 1 hour,

$$\Rightarrow \frac{1}{5} + \frac{1}{6} - \frac{1}{12} = \frac{17}{60}$$

This is a positive number. This means rate of filling is greater than rate of emptying and so the tank can be filled in some hours.

∴ The tank can be filled in $\frac{60}{17} = 3\frac{9}{17}$ hours.

3. Two pipes A and B can fill a cistern in $37\frac{1}{2}$ minutes and 45 minutes respectively. Both pipes are opened. The cistern will be filled in just half an hour, if pipe B is turned off after what time?

Solution –

Pipe A alone can fill the cistern in $37\frac{1}{2} = \frac{75}{2}$ minutes.

B was closed after some minutes but A was open for 30 minutes.

Since A was open for 30 minutes, part of the cistern filled by pipe A = $\frac{2}{75} \times 30 = \frac{4}{5}$

So the remaining = $1 - \frac{4}{5} = \frac{1}{5}$ part is filled by pipe B.

Pipe B can fill the cistern in 45 minutes. So, time required to fill $\frac{1}{5}$ part

$$= \frac{45}{5} = 9 \text{ minutes.}$$

∴ Pipe B is turned off after 9 minutes.

4. A water tank is two-fifth full. Pipe A can fill a tank in 12 minutes and pipe B can empty it in 6 minutes. If both the pipes are open, how long will it take to empty or fill the tank completely?

Solution –

Since pipe B is faster than pipe A, the tank will be emptied.

$$\text{Part filled by pipe A in 1 minute} = \frac{1}{12}$$

$$\text{Part emptied by pipe B in 1 minute} = \frac{1}{6}$$

$$\text{Net part emptied by pipe A and B in 1 minute} = \frac{1}{6} - \frac{1}{12} = \frac{1}{12}$$

So in 12 minutes, they will empty a full tank.

$$\therefore \text{Time taken to empty } \frac{2}{5} \text{ of the tank} = \frac{2}{5} \times 12 = 4.8 \text{ min.}$$

5. Three pipes A, B and C can fill a tank in 6 hours. After working at it together for 2 hours, C is closed and A and B can fill the remaining part in 7 hours. The number of hours taken by C alone to fill the tank is:

Solution –

A, B, C together can fill a tank in 6 hours.

$$\Rightarrow \text{Part filled by pipes A,B,C together in 1 hr} = \frac{1}{6}$$

All these pipes are open for only 2 hours and then C is closed.

$$\text{Part filled by pipes A,B,C together in these 2 hours} = \frac{2}{6} = \frac{1}{3}$$

$$\text{Remaining part} = 1 - \frac{1}{3} = \frac{2}{3}$$

This remaining part of $\frac{2}{3}$ is filled by pipes A and B in 7 hours.

$$\text{Therefore, part filled by pipes A and B in 1 hr} = \frac{\left(\frac{2}{3}\right)}{7} = \frac{2}{21}$$

$$\begin{aligned} &\text{Part filled by pipe C in 1 hr} \\ &= \frac{1}{6} - \frac{2}{21} = \frac{3}{42} = \frac{1}{14} \end{aligned}$$

- ∴ C alone can fill the tank in 14 hours.

TIME , DISTANCE AND SPEED

Relationship between Speed, Distance and Time –

1. Speed = $\frac{\text{Distance}}{\text{Time}}$
2. Distance = Speed × Time
3. Time = $\frac{\text{Distance}}{\text{Speed}}$

When using these equations, it is important to keep the units straight. For instance, if the rate of the problem is given in kilometres per hour (kmph), then the time needs to be in hours , and the distance in kilometres. If the time is given in minutes, you will need to divide by 60 to convert it to hours before you can use the equation to find the distance in kilometres.

- **Convert kilometres per hour (km/hr) to metres per second (m/s)**

$$x \text{ km / hr} = \left(x \times \frac{1000}{3600} \right) \text{ m / s} = \left(x \times \frac{5}{18} \right) \text{ m / s}$$

- **Convert metres per second (m/s) to kilometres per hour (km/hr)**

$$x \text{ m / s} = \left(x \times \frac{3600}{1000} \right) \text{ km / hr} = \left(x \times \frac{18}{5} \right) \text{ km / hr}$$

❖ Average Speed

If an object covers a certain distance at x kmph and an equal distance at y kmph, the average speed of the whole journey = $\frac{2xy}{x+y}$ km / hr

- ❖ If the ratio of the speeds of A and B is $a : b$, then, the ratio of the time taken by them to cover the same distance is

$$\frac{1}{a} : \frac{1}{b} = b : a$$

❖ **Relative Speed**

- If two objects are moving in the same direction at v_1 m/s and v_2 m/s respectively where $v_1 > v_2$, then their relative speed = $(v_1 - v_2)$ m / s
- If two objects are moving in opposite directions at v_1 m/s and v_2 m/s respectively, then their relative speed = $(v_1 + v_2)$ m/s

Solved examples:

1. a) Express speed of 72 km / hr in m / s .
b) Express speed of 25 m / s in km / hr .

Solution –

a) $72 \text{ km / hr} = \left(72 \times \frac{5}{18}\right) \text{ m / s} = 20 \text{ m / s}$

b) $25 \text{ m / s} = \left(25 \times \frac{18}{5}\right) \text{ km / hr} = 90 \text{ km / hr}$

2. A person crosses a 600 metre long street in 5 minutes. What is his speed in km per hour?

Solution –

Distance = 600 metre = 0.6 km

Time = 5 minutes = $\frac{1}{12}$ hour

Speed = $\frac{\text{Distance}}{\text{Time}} = \frac{0.6}{1/12} = 7.2 \text{ km/hr.}$

3. A man completes a journey in 10 hours. He travels first half of the journey at the rate of 21 km/hr and second half at the rate of 24 km/hr. Find the total journey in km.

Solution –

$$\begin{aligned} \text{Average Speed} &= \frac{2xy}{x+y} \\ &= \frac{2 \times 21 \times 24}{21 + 24} \text{ km / hr} = 22.4 \text{ km / hr} \end{aligned}$$

Total distance = $22.4 \times 10 = 224 \text{ km.}$

4. In covering a distance of 30 km, Arun takes 2 hours more than Anil. If Arun doubles his speed, then he would take 1 hour less than Anil. What is Arun's speed?

Solution –

Let speed of Arun = x kmph,
 speed of Anil = y kmph
 distance = 30 km

We know that Time = $\frac{\text{Distance}}{\text{Speed}}$ Hence,

$$\frac{30}{x} - \frac{30}{y} = 2 \dots(1)$$

$$\frac{30}{y} - \frac{30}{2x} = 1 \dots(2)$$

Adding (1) and (2)

$$\frac{30}{x} - \frac{30}{2x} = 3$$

$$\Rightarrow \frac{30}{2x} = 3$$

$$\Rightarrow \frac{15}{x} = 3$$

$$\Rightarrow \frac{5}{x} = 1$$

$$\Rightarrow x = 5$$

∴ Arun's speed = 5 kmph.

5. A man travelled a distance of 61 km in 9 hours. He travelled partly on foot at 4 km/hr and partly on bicycle at 9 km/hr. What is the distance travelled on foot?

Solution-

Let the time in which he travelled on foot = x hr

Then the time in which he travelled on bicycle = $(9-x)$ hr

Distance = speed \times time

$$\Rightarrow 4x + 9(9-x) = 61$$

$$\Rightarrow 4x + 81 - 9x = 61$$

$$\Rightarrow 5x = 20$$

$$\Rightarrow x = 4$$

∴ Distance travelled on foot = $4x = 16$ km.

Unit – 4: Concept of Angles, Different Polygons like triangles, rectangle, square, right angled triangle, Pythagorean Theorem, Perimeter and Area of Triangles, Rectangles, Circles

Concept of Angle

In plane geometry, an **angle** is the figure formed by two rays, called the *sides* of the angle, sharing common endpoint, called the vertex of the angle.

- Angles smaller than 90° are called **acute angles**.
- An angle equal to 90° is called a **right angle**.
- Angles larger than a right angle and smaller than 180° are called **obtuse angles**.

Triangle

A **triangle** is a polygon with three edges and three vertices. The sum of the 3 angles of a triangle is 180° .

Types of triangle:

1. An **equilateral triangle** has all sides the same length. An equilateral triangle is also a regular polygon with all angles measuring 60° .

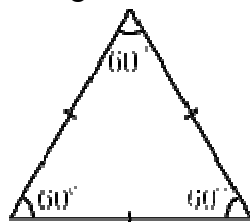

2. An **isosceles triangle** has two sides of equal length. An isosceles triangle also has two angles of the same measure, namely the angles opposite to the two sides of the same length.



3. A **scalene triangle** has all its sides of different lengths. Equivalently, it has all angles of different measure.

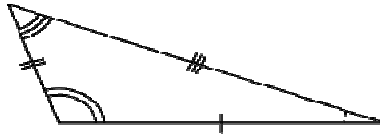

4. A **right triangle** (or right-angled triangle) has one of its interior angles measuring 90° (a right angle). The side opposite to the right angle is the hypotenuse, the longest side of the triangle.

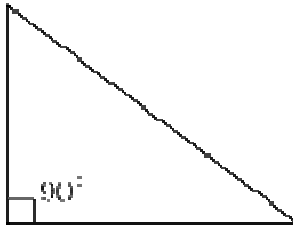

Perimeter and area

Let the length of the three sides of a triangle be a , b , c . Then,

- Perimeter of the triangle = $a + b + c$
- Area of the triangle = $\frac{1}{2} \times \text{base} \times \text{height}$
- Area = $\sqrt{s(s-a)(s-b)(s-c)}$ (if all the sides are given)
Where $s = \frac{1}{2}(a + b + c)$

- ❖ Let the side of an equilateral triangle be a . Then ,
- Perimeter of equilateral the triangle = $3 a$
- Area of the equilateral triangle = $\frac{\sqrt{3}}{4} \times a^2$

Pythagorean Theorem

It states that the square of the hypotenuse (the side opposite the right angle) is equal to the sum of the squares of the other two sides.

$$a^2 + b^2 = c^2$$

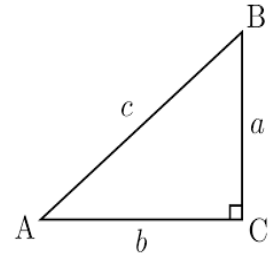

Solved examples:

1. Find the perimeter of the triangle having length of the sides 5 cm, 8 cm, 7 cm.

Solution:

Let a, b, c be the length of the sides of the given triangle.

So a = 5 cm, b = 8 cm, c = 7 cm.

$$\begin{aligned} \text{Perimeter of the triangle} &= (a + b + c) \text{ cm} \\ &= (5 + 8 + 7) \text{ cm} \\ &= 20 \text{ cm.} \end{aligned}$$

- ∴ Perimeter of the given triangle is 20 cm.

2. Find the area of the triangle whose sides measure 13 cm, 14 cm, 15 cm.

Solution –

Let a = 13 cm, b = 14 cm, c = 15 cm.

$$\begin{aligned} \text{Then } s &= \frac{1}{2}(a + b + c) \\ &= \frac{1}{2}(13 + 14 + 15) = 21 \text{ cm.} \end{aligned}$$

$$\begin{aligned} \text{Area of the triangle} &= \sqrt{s(s-a)(s-b)(s-c)} = \sqrt{21(21-13)(21-14)(21-15)} \\ &= \sqrt{21 \times 8 \times 7 \times 6} \\ &= 84 \text{ cm}^2 \end{aligned}$$

- ∴ Area of the triangle is 84 cm².

3. Let the perimeter of an equilateral triangle be 27 cm. Then find the length of its sides.

Solution:

Given perimeter of the equilateral triangle = 27 cm

Let a be the length of the side of the equilateral triangle.

$$\Rightarrow 3a = 27$$

$$\Rightarrow a = \frac{27}{3} = 9 \text{ cm}$$

∴ Length of the side of the equilateral triangle is 9 cm.

4. Find the area of the equilateral triangle having sides of length 8 cm.

Solution:

Given length of the side of the equilateral triangle = 8 cm

$$\begin{aligned} \text{Area of the triangle} &= \frac{\sqrt{3}}{4} \times a^2 \\ &= \frac{\sqrt{3}}{4} \times (8)^2 \\ &= 16\sqrt{3} \text{ cm}^2 \end{aligned}$$

∴ Area of the given equilateral triangle is $16\sqrt{3} \text{ cm}^2$.

5. Find the length of the hypotenuse of the right angled triangle when the length of the base and the perpendicular are 5 cm and 12 cm respectively.

Solution:

Given length of the base (b) = 5 cm

length of the perpendicular (a) = 12 cm

Using Pythagorean theorem, $a^2 + b^2 = c^2$

$$\Rightarrow c^2 = 5^2 + 12^2$$

$$\Rightarrow c^2 = 25 + 144$$

$$\Rightarrow c^2 = 169$$

$$\Rightarrow c = 13 \text{ cm}$$

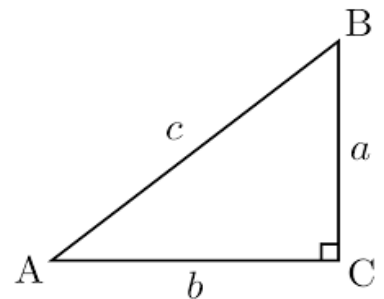

∴ Length of hypotenuse of the triangle is 13 cm.

6. The base of a triangular field is three times its altitude. If the cost of cultivating the field at Rs. 24.68 per hectare be Rs.333.18, find its base and height.

Solution –

$$\begin{aligned} \text{Area of the field} &= \frac{\text{total cost}}{\text{rate}} = \frac{333.18}{24.68} = 13.5 \text{ hectares} \quad [1 \text{ hectare} = 100\text{m} \times 100\text{m}] \\ &= (13.5 \times 10000) \text{ m}^2 = 135000 \text{ m}^2 \end{aligned}$$

Let altitude = x metres and base = 3x metres.

Then, $\frac{1}{2} \times 3x \times x = 135000$

$\Rightarrow x^2 = 90000$

$\Rightarrow x = 300$ metres

Thus, base = 900 metres and altitude = 300 metres.

7. The altitude drawn to the base of the isosceles triangle is 8 cm and the perimeter is 32 cm. Find the area of the triangle.

Solution:

Let ABC be an isosceles triangle and AD be its altitude.

Let $AB = AC = x$ cm. Then $BC = (32 - (AB + AC))$
 $= (32 - 2x)$ cm

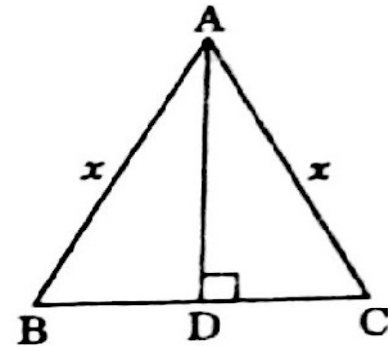

Since in an isosceles triangle the altitude bisects the base, so we have $BD = CD = (16 - x)$ cm

In triangle ADC, $AD^2 + CD^2 = AC^2$

$\Rightarrow x^2 = 8^2 + (16 - x)^2$

$\Rightarrow x^2 = 64 + 256 + x^2 - 32x$

$\Rightarrow 32x = 320$

$\Rightarrow x = 10$

So $BC = (32 - 2x) = (32 - 20) = 12$ cm

Now Area of the triangle = $\frac{1}{2} \times \text{base} \times \text{height}$

$= \frac{1}{2} \times 12 \times 8$

$= 48 \text{ cm}^2$

∴ Area of the triangle is 48 cm^2 .

Rectangle

A **rectangle** is a quadrilateral with four right angles. In a rectangle both pairs of opposite sides are parallel and equal in length. The sum of the angles of a rectangle is 360° .

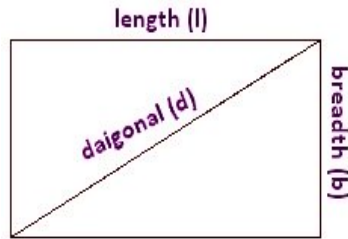

Perimeter and area

If a rectangle has length l and width b ,

- it has perimeter $P = 2(l + b)$
- it has area $A = l \times b$

Solved examples:

1. Find the area and the perimeter of a rectangle having length 12 cm and breadth 10cm.

Solution –

Given Length of the rectangle = 12 cm

Breadth of the rectangle = 10 cm

$$\begin{aligned} \text{Perimeter} &= 2(l + b) = 2(12 + 10) \\ &= 44 \text{ cm.} \end{aligned}$$

$$\text{Area} = l \times b = 12 \times 10 = 120 \text{ cm}^2.$$

- ∴ Area and perimeter of the triangle are 120 cm^2 & 44 cm respectively.

2. A field is in the form of a rectangle having its sides in the ratio 2 : 3. The area of the field is 1.5 hectares. Find the length and breadth of the field.

Solution:

Let length = $2x$ and breadth = $3x$ metres.

$$\text{Area} = 1.5 \text{ hectares} = 1.5 \times 10000 \text{ m}^2 = 15000 \text{ m}^2. \text{ [1 hectare} = 100\text{m} \times 100\text{m}]$$

$$\Rightarrow 2x \times 3x = 15000$$

$$\Rightarrow 6x^2 = 15000$$

$$\Rightarrow x^2 = 2500$$

$$\Rightarrow x = 50 \text{ metres}$$

Length = $2x = 100$ metres and breadth = $3x = 150$ metres.

- ∴ The length and breadth of the rectangle is 100 m & 150 cm respectively.

3. If three angles of a quadrilateral are 50° , 75° and 80° , then find the remaining angle of the quadrilateral.

Solution:

Given three angle of the quadrilateral are 50° , 75° and 80° .

We know that the sum of the angles of a quadrilateral is 360° .

$$\begin{aligned}\text{Hence the remaining angle} &= 360^\circ - (50^\circ + 75^\circ + 80^\circ) \\ &= 360^\circ - 205^\circ \\ &= 155^\circ\end{aligned}$$

4. Let one side and a diagonal of a rectangle be 6 cm & 10 cm respectively, then find the area of the rectangle.

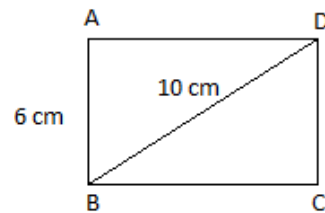

Solution:

Given breadth of the rectangle = 6 cm

Length of the diagonal = 10 cm

ΔABD is a right angle triangle. So we have $BD^2 = AD^2 + AB^2$

$$\Rightarrow 10^2 = AD^2 + 6^2$$

$$\Rightarrow 100 = AD^2 + 36$$

$$\Rightarrow AD^2 = 64$$

$$\Rightarrow AD = 8 \text{ cm}$$

Area of ABCD = $AD \times AB$

$$= 6 \times 8 = 48 \text{ cm}^2$$

- ∴ Area of the given rectangle is 48 cm^2 .

5. The length of a rectangle is 8 cm and the width is 5 cm. If the length is greater by 2 cm, what should the width be so that the new rectangle has the same area as the first one?

Solution:

Given length of the rectangle = 8 cm

Breadth of the rectangle = 5 cm

So area of the rectangle = $l \times b = 8 \times 5 = 40\text{cm}^2$

If the length is increased by 2 cm, then the new length of the rectangle = 10 cm.

Area = $l \times b$

$$\Rightarrow 40 = 10 \times b$$

$$\Rightarrow b = 4 \text{ cm.}$$

- ∴ The new width of the rectangle is 4 cm.

Square

A **square** is a regular quadrilateral, which means that it has four equal sides and four equal angles (i.e. 90°).

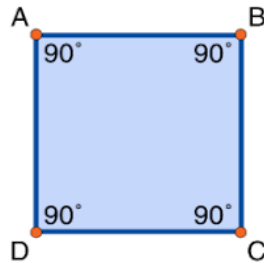

Perimeter and area

- The perimeter of a square whose four sides have length l is $P = 4l$
- And the area $A = l^2$

Solved examples:

1. Find the area and the perimeter of the square having sides 6 cm.

Solution:

Given length of the side $l = 6 \text{ cm}$

$$\begin{aligned}\text{So perimeter } P &= 4l \\ &= 4 \times 6 = 24 \text{ cm}\end{aligned}$$

Area $A = l^2$

$$\Rightarrow A = 6^2 = 36 \text{ cm}^2$$

∴ Perimeter and area of the given square is 24 cm & 36 cm² respectively.

2. Find the perimeter of the square whose area is 100 cm².

Solution:

Let the sides of the square be $a \text{ cm}$.

Given area of the square = 100 cm².

$$\Rightarrow a^2 = 100$$

$$\Rightarrow a = 10 \text{ cm.}$$

Perimeter = $4 \times a = 4 \times 10 = 40 \text{ cm}$

∴ Perimeter of the square is 40 cm.

3. Find the length of the diagonal of the square having sides 9 cm.

Solution:

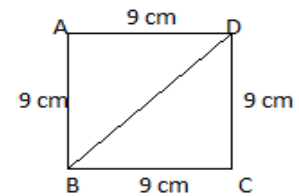

Let ABCD be a square having sides 9 cm.

ΔABD is a right angle triangle. So we have $BD^2 = AD^2 + AB^2$

$$\Rightarrow BD^2 = 9^2 + 9^2$$

$$\Rightarrow BD^2 = 162$$

$$\Rightarrow BD = 9\sqrt{2} \text{ cm}$$

∴ Length of the diagonal is $9\sqrt{2} \text{ cm}$.

- ❖ If a is the length of the side of a square, then its diagonal = $a\sqrt{2}$
- ❖ If d is the length of the diagonal of a square, then the length of its sides = $\frac{d}{\sqrt{2}}$

4. Find the area of a square whose diagonal is 4 cm.

Solution:

Given length of the diagonal of a square = 4 cm

$$\text{Length of its sides} = \frac{d}{\sqrt{2}} = \frac{4}{\sqrt{2}} = 2\sqrt{2} \text{ cm}$$

$$\text{Area of the square} = 2\sqrt{2} \times 2\sqrt{2} = 8 \text{ cm}^2$$

- ∴ Area of the square is 8 cm².

$$\text{❖ Area of square} = \frac{1}{2}(d)^2 \text{ (if length of the diagonal is given)}$$

5. The perimeter of a square courtyard is 100 m. find the cost of cementing it at the rate of Rs. 5 per m².

Solution:

Perimeter of square courtyard = 100 m

$$\text{Therefore, side of the square courtyard} = \frac{100}{4} = 25 \text{ m}$$

$$\text{Therefore, area of square courtyard} = (25 \times 25) \text{ m}^2 = 625 \text{ m}^2$$

For 1 m², the cost of cementing = Rs. 5

$$\text{For } 625 \text{ m}^2, \text{ the cost of cementing} = 625 \times 5 = \text{Rs. } 3125$$

Circle

A **circle** is a simple closed shape. It is the set of all points in a plane that are at a given distance from a given point, the centre; equivalently it is the curve traced out by a point that moves so that its distance from centre is constant.

- A circle has a total of **360 degrees** all the way around the center,

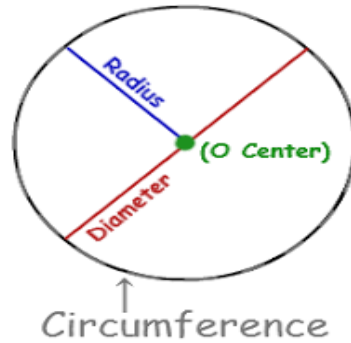

Perimeter and area

Let the radius of a circle be r . Then,

- Perimeter/Circumference of the circle = $2\pi r$
- Area of the circle = πr^2

Solved examples:

1. Find the circumference of a circle having radius 21 cm.

Solution:

Given $r = 21$ cm

Circumference = $2\pi r$

$$\begin{aligned} &= 2 \times \frac{22}{7} \times 21 \\ &= 132 \text{ cm.} \end{aligned}$$

∴ Circumference of the circle is 132 cm.

2. Find the area of the circle having radius 7 cm.

Solution:

Given radius of the circle (r) = 7 cm

Area = πr^2

$$= \frac{22}{7} \times 7^2 = 154 \text{ cm}^2.$$

∴ Area of the circle is 154 cm^2 .

3. A wheel makes 200 revolutions in covering a distance of 44 km. Find the radius of the wheel.

Solution:

Distance covered in 200 revolutions = 44 km = $(44 \times 1000) \text{ m} = 44000 \text{ m}$

$$\Rightarrow \text{Distance covered in 1 revolution} = \frac{44000}{200} = 220 \text{ m}$$

Distance covered in 1 revolution = perimeter of the wheel

$$\Rightarrow 2\pi r = 220$$

$$\Rightarrow 2 \times \frac{22}{7} \times r = 220$$

$$\Rightarrow r = 220 \times \frac{7}{22} \times \frac{1}{2}$$

$$\Rightarrow r = 35 \text{ cm.}$$

∴ Radius of the wheel is 35 cm.

4. Two concentric circles form a ring. The inner and the outer circumference of the ring are 132 cm & 176 cm respectively. Then find the width of the ring.

Solution:

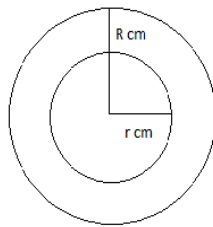

Let R and r be the radii of the outer and inner circles respectively.

According to the question, for the outer circle, $2\pi R = 176 \text{ cm}$

$$\Rightarrow 2 \times \frac{22}{7} \times R = 176$$

$$\Rightarrow R = 176 \times \frac{7}{22} \times \frac{1}{2}$$

$$\Rightarrow R = 28 \text{ cm}$$

Similarly for the inner circle, $2\pi r = 132$

$$\Rightarrow 2 \times \frac{22}{7} \times r = 132$$

$$\Rightarrow r = 132 \times \frac{7}{22} \times \frac{1}{2}$$

$$\Rightarrow r = 21 \text{ cm}$$

∴ Width of the ring = $R - r = 28 \text{ cm} - 21 \text{ cm} = 7 \text{ cm}$.

5. If the radius of a circle is decreased by 50%, then find the % decrease in area.

Solution:

Let the radius of a circle = $r \text{ cm}$

So area of the circle = πr^2

Now if the radius decreases by 50% the new radius (R) = 50% of r

$$= \frac{50}{100} \times r = \frac{r}{2}$$

$$\text{The new area} = \pi R^2 = \pi \left(\frac{r}{2}\right)^2 = \frac{\pi r^2}{4}$$

$$\text{Decrease in area} = \frac{\text{change in area}}{\text{original area}} \times 100 = \frac{\pi r^2 - \frac{\pi r^2}{4}}{\pi r^2} \times 100 = \frac{\frac{3\pi r^2}{4}}{\pi r^2} \times 100 = 75\%$$

∴ Decrease in area = 75%.

Unit – 5: Raw and Grouped Data, Bar Graphs, Pie charts, Mean, Median and Mode, Events and Sample Space, Probability

Data analysis is an important aspect of almost every competitive exam today. Usually, a table or a bar diagram or a pie chart or a sub-divided bar diagram or a graph is given and candidates are asked questions that test their ability to analyze the data given in those forms.

Raw data

Raw data or primary data are collected directly related to their object of study (statistical units). When people are the subject of an investigation, we may choose the form of a survey, an observation or an experiment.

Examples:

Let us consider the marks secured by 20 students of a class (total mark 500)

453	301	220	485	211
420	143	388	357	229
98	448	429	190	150

490	324	256	373	389
-----	-----	-----	-----	-----

This is called raw data i.e. not processed; only gathered.

Grouped data

Grouped data are data formed by aggregating individual observations of a variable into groups, so that a frequency distribution of these groups serves as a convenient means of summarizing or analyzing the data.

Example:

One way of arranging the above data is as below

Marks	Number of students
0 – 100	1
100- 200	3
200 - 300	4
300 – 400	6
400 - 500	6

This is called grouping of data i.e. arranging data in a particular way.

Bar Graphs

A **bar graph** (also called bar chart) is a graphical display of data using bars of different heights.

We can use bar graphs to show the relative sizes of many things, such as what type of car people have, how many customers a shop has on different days and so on.

Solved examples:

1. Study the following graph and answer the questions.

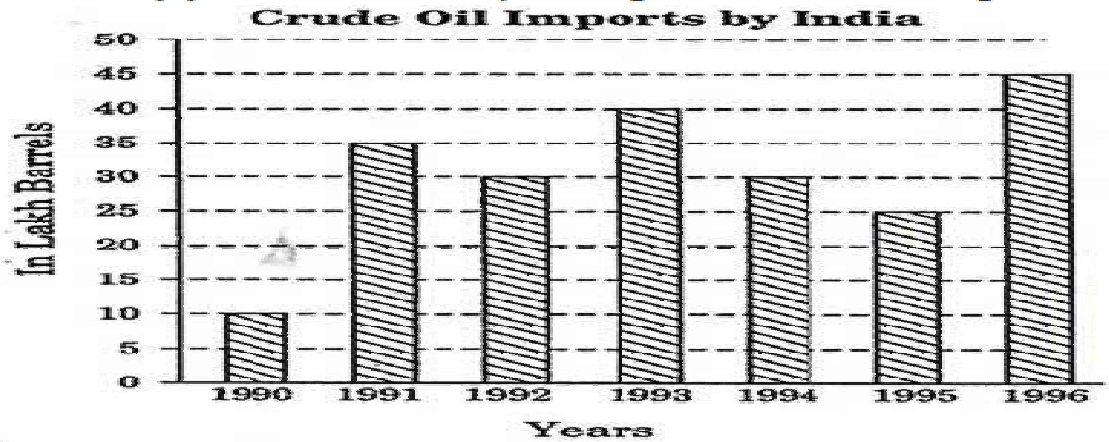

QA. From the graph calculate the sum of crude oil imports in the years 1991 & 1996.

Solution: Crude oil import in the year 1991 = 35 lakh barrels

Crude oil import in the year 1996 = 45 lakh barrels

Sum = 35 + 45 = 80 lakh barrels.

QB. Calculate the average crude oil imports by India during 1990 – 1996.

Solution: sum of crude oil imports during 1990 – 1996 = 10 + 35 + 30 + 40 + 30 + 25 + 45
= 215 lakh barrels.

Hence, average = $\frac{215}{7} = 30.71$ lakh barrels.

QC. In which year(s) the crude oil import was greater than average import?

Solution:

From above we have average = 30.71 lakh barrels

Hence, in the years 1991, 1993, 1996 the crude oil import was greater than the average.

2. The following bar graph shows the population of two states A & B in lakhs.

Answer the following questions based on the data given below.

Population of two states (in lakhs) over the years

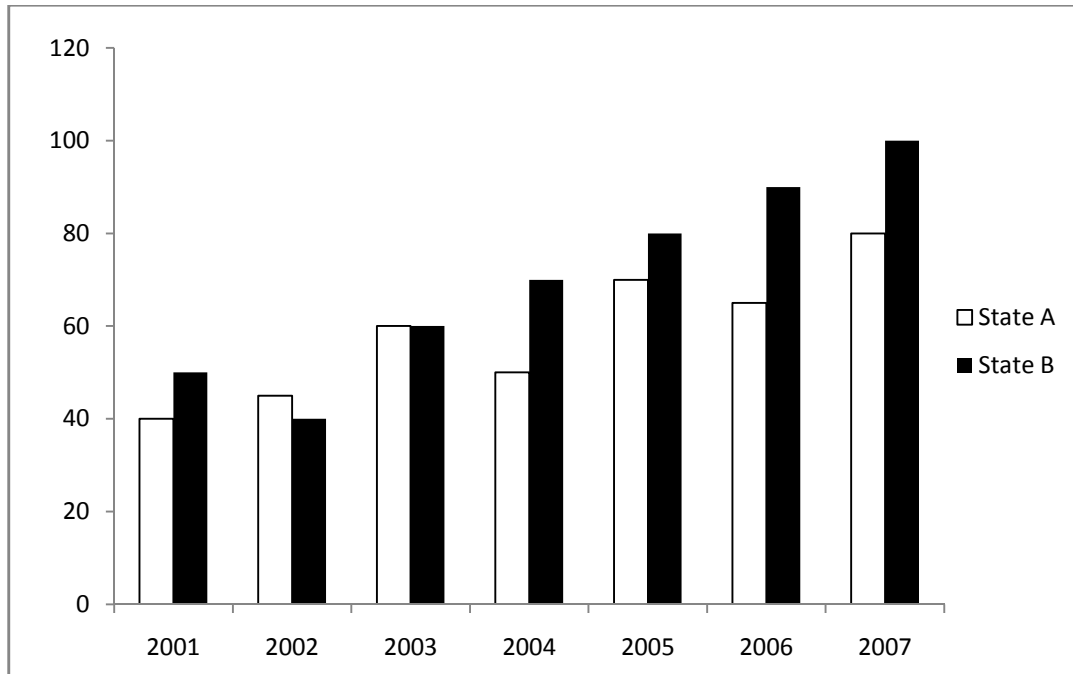

Number of years

Q A: Approximately, what is the average population of state A for all the given years?

Solution:

Total population of State A = 410 Lakhs

$$\begin{aligned} \text{Average Population of State A} &= \frac{\text{Total population of State A}}{\text{Number of Years}} = \frac{40+45+60+50+70+65+80}{7} \\ &= \frac{410}{7} = 58.57 \text{ Lakhs} \end{aligned}$$

Therefore, The approx average population of State A is 59 Lakhs.

Q B: What is the ratio of the total population of state A for the years 2001, 2002 and 2003 together to the population of state B for 2005, 2006 and 2007 together?

Solution:

$$\begin{aligned} \text{As we need to find ratio, State A (2001 + 2002 + 2003) : State B(2005 + 2006 +2007)} \\ &= (40 + 45 + 60) : (80+ 90+100) \\ &= 145: 270 = 29:54 \end{aligned}$$

Therefore the ratio of number of people in the state A (2001 + 2002 + 2003) to the number of people in the state B (2005 + 2006+ 2007) is 29 : 54.

Q C: What is the percentage rise in population of state B from the year 2003 to 2004?

Solution:

As we need to find the percentage rise in the population,

$$\text{Percentage change} = \frac{\text{change in value}}{\text{reference value}} \times 100$$

$$\text{So, Percentage Increase} = \frac{70-60}{60} \times 100$$

$$= \frac{10}{60} \times 100 = 16.66\%$$

Therefore, there has been a rise in 16.66% of population during the year 2003 and 2004 in State B.

3. The bar graph given below shows the foreign exchange reserves of a country (in million US \$) from 1991 - 1992 to 1998 - 1999.

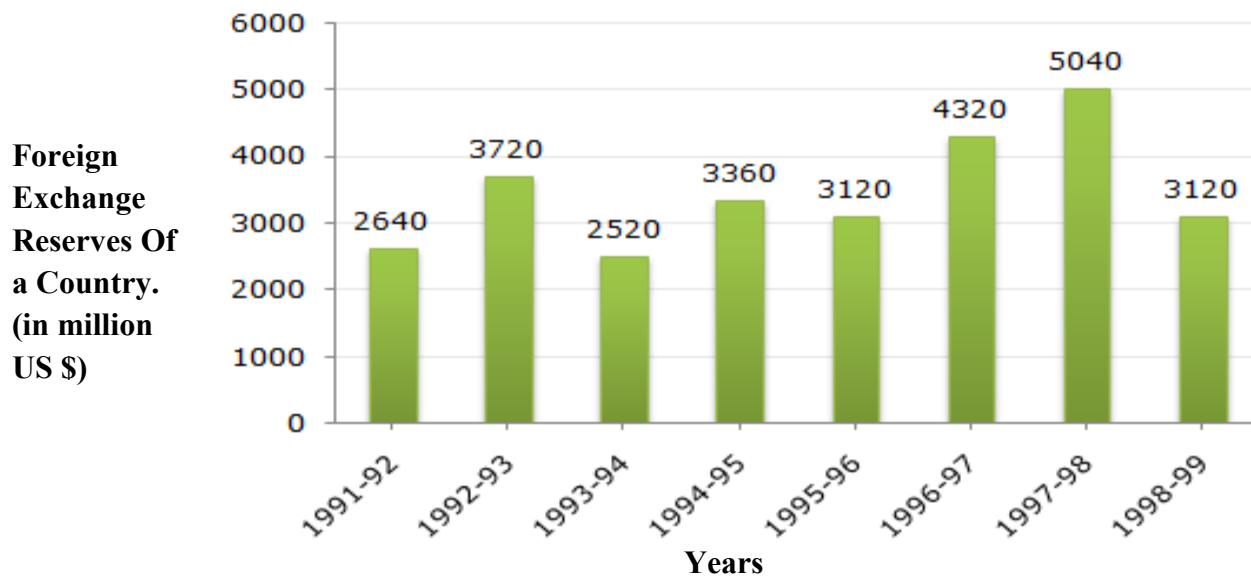

Q A. Calculate the average foreign reserves of the country from 1991 - 1992 to 1998 – 1999.

Solution:

$$\text{Sum of foreign reserves of the country} = (2640 + 3720 + 2520 + 3360 + 3120 + 4320 + 5040 + 3120) \text{ million US \$}.$$

$$= 27840 \text{ million US \$}.$$

Hence, average = $\frac{\text{sum}}{8} = \frac{27840}{8} = 3480$ million US \$.

Q B. The foreign exchange reserves in 1997-98 were how many times that in 1994-95?

Solution:

Required ratio = $\frac{\text{foreign exchange reserves in 1997-98}}{\text{foreign exchange reserves in 1994-95}} = \frac{5040}{3360} = 1.5$.

Q C. What was the percentage increase in the foreign exchange reserves in 1997-98 over 1993-94?

Solution:

Foreign exchange reserves in 1997 - 1998 = 5040 million US \$.

Foreign exchange reserves in 1993 - 1994 = 2520 million US \$.

Increase = $(5040 - 2520) = 2520$ million US \$.

Percentage increase = $\left(\frac{2520}{2520} \times 100\right) \% = 100\%$.

Pie chart

A pie is a baked dish which is round in shape. A pie chart or pie graph is a special chart that uses “pie slices” to show relative sizes of data. The chart is divided into sectors, where each sector shows the relative size of each value.

Solved examples:

1. The following pie-chart shows the percentage distribution of the expenditure incurred in publishing a book. Study the pie-chart and the answer the questions based on it.

Various Expenditures (in percentage) Incurred in Publishing a Book

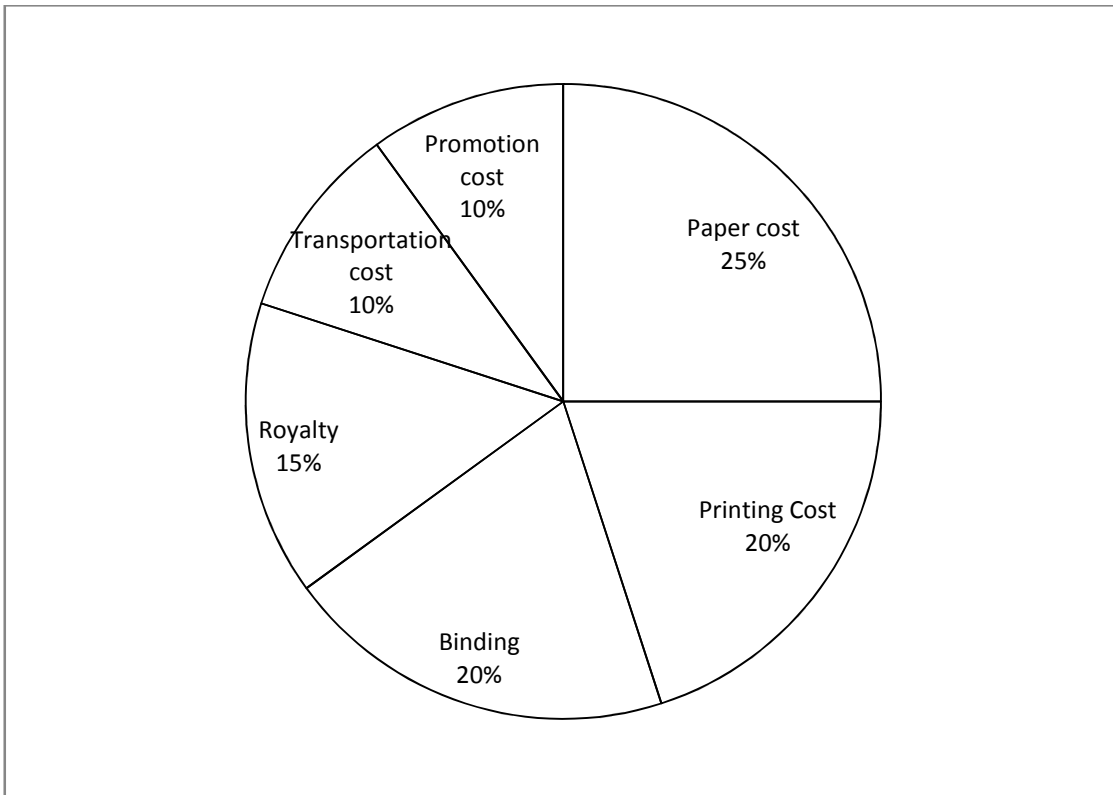

QA. If for a certain quantity of books, the publisher has to pay Rs. 30,600 as printing cost then, what will be amount of royalty to be paid for these books?

Solution:

Given that the printing cost = Rs. 30,600

Let the royalty to be paid be Rs. x .

So we can write, $\frac{20\% \text{ of total cost}}{15\% \text{ of total cost}} = \frac{30,600}{x}$

$$\Rightarrow 20 \times x = 15 \times 30,600$$

$$\Rightarrow x = \frac{15 \times 30,600}{20} = \text{Rs. } 22,950$$

Hence royalty to be paid = Rs. 22,950

Q B. Promotion cost on the book is less than the paper cost by what percentage?

Solution:

Promotion cost of book = 10% of C.P.

paper cost on book = 25% of C.P.

Difference = (25% of C.P.) - (10% of C.P.) = 15% of C.P.

$$\begin{aligned} \text{Percentage difference} &= \left(\frac{\text{Difference}}{\text{paper cost}} \times 100 \right) \% \\ &= \left(\frac{15 \% \text{ of C.P.}}{25 \% \text{ of C.P.}} \times 100 \right) \% = 60\% . \end{aligned}$$

QC . If the total cost of printing a certain quantity of books is Rs.2,50,000. Then find the sum of its transportation cost, promotion cost and binding cost.

Solution:

Given that the total cost = Rs.2,50,000

Sum = (10 % of total cost) + (10 % of total cost) + (20 % of total cost)

= (10% + 10% + 20%) of 2,50,000

= $\frac{40}{100} \times 2,50,000$

= Rs. 1,00,000

2. The following pie chart shows the amount of subscriptions generated for India bonds for different categories of investors.

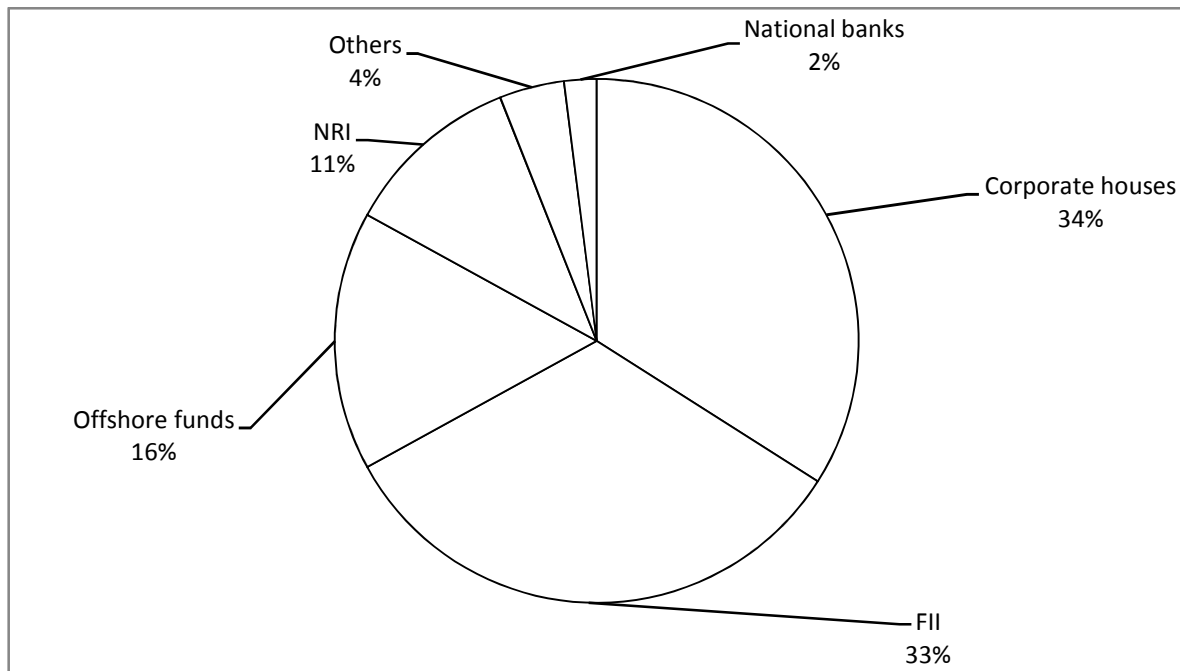

Q A. If the investments by NRIs are Rs 1100 crore, then the investment by corporate houses and FIIs together is:

Solution:

Let the investment by corporate houses and FIIs together is be x.

So we can write, $\frac{11\% \text{ of total investments}}{34\% \text{ of total investments} + 33\% \text{ of total investments}} = \frac{1100}{x}$

$$\Rightarrow \frac{11}{34+33} = \frac{1100}{x}$$

$$\Rightarrow x = \frac{1100 \times 67}{11} = 6700 \text{ crore}$$

The investment by corporate houses & FII is = 6700 crore.

Q B. What is the approximate ratio of investment flows into India Bonds from NRIs to corporate houses?

Solution:

Investment flows into India Bonds from NRIs = 11%

Investment flows into India Bonds from corporate houses = 34%

Required ratio = 11 : 34 = 1 : 3 (approx.)

QC. In the corporate sector, how many degrees should be there in the central angle?

Solution:

From the above pie chart we have corporate sector = 34% of total subscriptions

As we know a circle has a total of 360 degrees.

So, 100 % of total subscriptions = 360°

$$\Rightarrow 1 \% \text{ of total subscriptions} = 3.6^\circ$$

$$\Rightarrow 34\% \text{ of total subscriptions} = 34 \times 3.6 = 122.4^\circ.$$

3. The following pie charts Figures (a) and (b) give the information about the distribution of weight in the human body according to different kinds of components. Study the pie charts carefully and answer the question given.

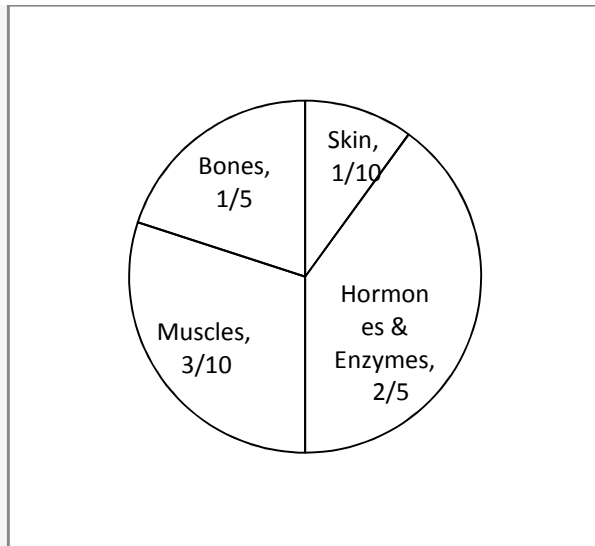
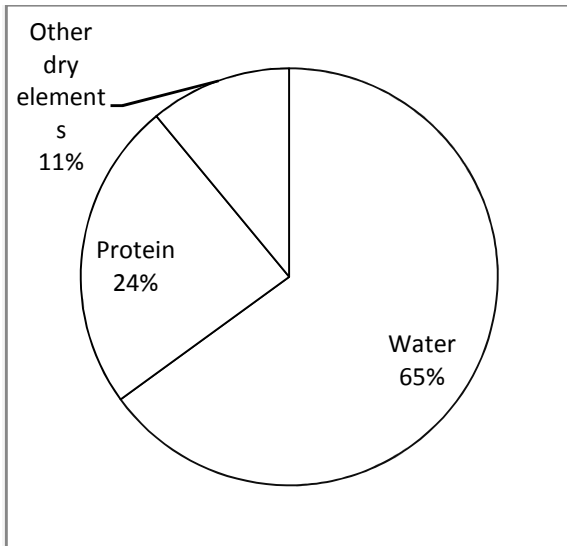

QA. What percentage of proteins of the human body is equivalent to the weight of its skin?

Solution:

Proteins contribute 24% of human weight.

Skin contributes = $\frac{1}{10} \times 100 = 10\%$ of human weight.

Let's say weight of human body is 100 kg.

\Rightarrow Weight of proteins = 24% of 100 kg = 24 kg and

Weight of skin = 10% of 100 kg = 10kg

Now 10 kg is equivalent to $\frac{10}{24} \times 100\% = 41.66\%$.

So 41.66% of proteins of the human body is equivalent to the weight of its skin.

Q B. If the skin weighs 12 kg, then find the weight of water.

Solution:

Let the weight of water be x kg.

Given that skin weighs 12 kg

$$\Rightarrow \frac{\frac{1}{10} \text{ of total body weight}}{\frac{65}{100} \text{ of total body weight}} = \frac{12}{x}$$

$$\Rightarrow x = 12 \times \frac{65}{100} \times 10 = 78 \text{ kg.}$$

Now weight of water = 78 kg.

QC. If the total weight of the body is 47 kg, then find out the difference between weight of bones and other dry elements.

Solution:

Given total weight of the body is 47 kg

$$\text{Weight of bones} = \frac{1}{5} \times 47 = 9.4 \text{ kg}$$

$$\text{Weight of dry elements} = \frac{11}{100} \times 47 = 5.17 \text{ kg.}$$

$$\text{Difference} = 9.4 \text{ kg} - 5.17 \text{ kg} = 4.23 \text{ kg}$$

Mean, Median & Mode

Mean:

Mean is basically the average found by adding all data values and dividing by the number of data values.

The mean (m) of a sample of n values $x_1, x_2, x_3, x_4, \dots, x_n$, is

$$m = \frac{x_1 + x_2 + x_3 + x_4 + \dots + x_n}{n}$$

Examples:

1. Find the mean of 5, 11, 16, 10, 18.

Solution:

$$\text{Mean (m)} = \frac{x_1 + x_2 + x_3 + x_4 + \dots + x_n}{n} = \frac{5+11+16+10+18}{5} = \frac{60}{5} = 12$$

2. Find the mean of 1.2, 3.15, 4.19, 4.22, 5.75, 1.90.

Solution:

$$m = \frac{x_1 + x_2 + x_3 + x_4 + \dots + x_n}{n} = \frac{1.2+3.15+4.19+4.22+5.75+1.90}{6} = 3.4$$

3. Find the mean of first five multiples of 8.

Solution:

The first five multiples of 8 are 8, 16, 24, 32, and 40.

$$\text{Mean} = \frac{8+16+24+32+40}{5} = \frac{120}{5} = 24.$$

4. There are two sections A and B of a class, consisting of 25 and 32 students' respectively. If the average weight of section A is 45kg and that of section B is 43kg, find the average weight of the whole class.

Solution:

Average weight of 25 students of section A = 45 kg

⇒ Total weight of 25 students of section A = $45 \times 25 = 1125$ kg

Average weight of 32 students of section B = 43 kg

⇒ Total weight of 32 students of section A = $43 \times 32 = 1376$ kg

Now average weight of whole class = $\frac{\text{total weight}}{\text{total no of students}} = \frac{1125+1376}{25+32} = \frac{2501}{57} = 43.87$ kg.

5. The mean of 25 numbers is 48. If two numbers, 15 and 17 are discarded, then find the mean of the remaining numbers.

Solution:

Average of 25 numbers = 48

⇒ Sum = $48 \times 25 = 1200$

If 15 and 17 are discarded then new sum = $1200 - (15 + 17) = 1168$

New mean = $\frac{1168}{23} = 50.78$.

Median:

Median is the middle value for a set of data that has been arranged in order of smallest to largest.

To find median of **n** no. of values first we have to arrange the given values in ascending order.

$\begin{aligned} \text{Median} &= \text{the value in } \left(\frac{n+1}{2}\right)\text{th place} && \text{(if n is odd)} \\ &= \frac{\text{the value in } \left(\frac{n}{2}\right)\text{th place} + \text{the value in } \left(\frac{n}{2} + 1\right)\text{th place}}{2} && \text{(if n is even)} \end{aligned}$
--

Solved examples:

1. Find the median for the following data.

96, 37, 14, 35, 55, 110, 24

Solution:

Arranging the above data we have,

14, 24, 35, 37, 55, 96, 110

Here $n = 7$ (odd)

So, median = the value in $\left(\frac{n+1}{2}\right)$ th place = the value in 4th place = 37.

2. Find the median for the following data set:

140, 27, 38, 23, 69, 121, 15, 52.

Solution:

Arranging the above data we have,

15, 23, 27, 38, 52, 69, 121, 140

Here $n=8$ (even)

$$\begin{aligned}\text{So median} &= \frac{\text{the value in } \left(\frac{n}{2}\right)\text{th place} + \text{the value in } \left(\frac{n}{2} + 1\right)\text{th place}}{2} \\ &= \frac{38+52}{2} = 45.\end{aligned}$$

3. Find the median for the following data set:

36, 53, 1.2, 3.9, 47, 12.6

Solution:

Arranging the above data we have,

1.2, 3.9, 12.6, 36, 47, 53

Here $n=6$ (even)

$$\begin{aligned}\text{So, median} &= \frac{\text{the value in } \left(\frac{n}{2}\right)\text{th place} + \text{the value in } \left(\frac{n}{2} + 1\right)\text{th place}}{2} \\ &= \frac{12.6+36}{2} = 24.3.\end{aligned}$$

4. Find the median for a set containing squares of all the even numbers between 1 to 20.

Solution:

We need to find median of squares of the set (2, 4, 6, 8, 10, 12, 14, 16, 18)

Here $n = 9$ (odd)

So desired value is square of 5th value = $10^2 = 100$

5. Find the median $\frac{3}{5}, \frac{1}{2}, \frac{12}{13}, \frac{6}{5}, \frac{1}{6}, \frac{7}{9}$.

Solution:

Now to arrange the above fractions in ascending order first we have to a common multiple of all the denominators.

So the common multiple of 5, 2, 13, 5, 6, 9 is 1170

$$\frac{3}{5} = \frac{3 \times 234}{5 \times 234} = \frac{702}{1170}$$

$$\frac{1}{2} = \frac{1 \times 585}{2 \times 585} = \frac{585}{1170}$$

$$\frac{12}{13} = \frac{12 \times 90}{13 \times 90} = \frac{1080}{1170}$$

$$\frac{6}{5} = \frac{6 \times 234}{5 \times 234} = \frac{1404}{1170}$$

$$\frac{1}{6} = \frac{1 \times 195}{6 \times 195} = \frac{195}{1170}$$

$$\frac{7}{9} = \frac{7 \times 130}{9 \times 130} = \frac{910}{1170}$$

Now arranging the above data according to the above values we have,

$$\frac{1}{6}, \frac{1}{2}, \frac{3}{5}, \frac{7}{9}, \frac{12}{13}, \frac{6}{5}$$

$$\begin{aligned} \text{So median} &= \frac{\text{the value in } \left(\frac{n}{2}\right)\text{th place} + \text{the value in } \left(\frac{n}{2} + 1\right)\text{th place}}{2} \\ &= \frac{\frac{3}{5} + \frac{7}{9}}{2} = \frac{31}{45} \end{aligned}$$

Mode

Mode is the most frequent value in a data set. There can be no mode, one mode or multiple modes in a data set.

Solved examples:

1. Find the mode of the following set of scores.

$$4, 2, 8, 9, 2, 7, 2, 11$$

Solution:

Mode = 2, since it occurs 3 times in the given data set, which is more than any other value.

2. Find the mode of the following data set.

53, 23, 18, 23, 23, 96, 84, 53, 107, 88, 53.

Solution:

Mode = 53 and 23 (both occurs most frequently i.e. 3 times)

3. The following frequency table shows the marks obtained by students in a quiz. Given that 3 marks is the only mode, what is the least value for x ?

Marks	1	2	3	4	5	6
Number of students	15	13	x	9	7	3

Solution:

Given that 3 is the only mode of the data set.

$\Rightarrow x$ is at least 16 (if x is less than 16 then 3 will not be the mode)

4. Find the mode of the following data set.

1020, 962, 321, 1020, 420, 786, 962, 420, 962, 333, 469, 656.

Solution:

1020, 962, 420 are the modes. (Each occurs most frequently i.e. 2 times)

5. A marathon race was completed by 5 participants. What is the mode of times taken by them? (given in hours)

2.7, 8.3, 3.5, 5.1, 4.9

Solution:

Ordering the data in ascending order we get,

2.7, 3.5, 4.9, 5.1, 8.3

Since each value occurs only once in the data set, there is no mode for this set of data.

Probability

Probability is a measurement of uncertainty.

- Random experiment:

A random experiment is an experiment or a process for which the outcome cannot be predicted with certainty and the process repeatedly occurs under homogeneous conditions.

- Outcome:

An **outcome** is a result of a random experiment.

- Sample space(S):

The set of all possible outcomes is called the **sample space**.

- Event(E):

In **probability** theory, an **event** is a set of outcomes of an experiment (a subset of the sample space).

Example

➤ Rolling a dice is a random experiment.

Here the number of possible outcomes 6.

Sample space = {1, 2, 3, 4, 5, 6}

Getting an even number is an event.

$$\text{Probability of an event} = \frac{\text{total no of elements in the event set (n(E))}}{\text{total no.of elements in the sample space(n(S))}}$$

❖ Points to remember

- $P(S) = 1$
- $0 \leq P(E) \leq 1$

Solved examples:

1. Find the probability of getting an odd no. when a dice is thrown?

Solution:

Here $S = \{1, 2, 3, 4, 5, 6\}$

$E = \{1, 3, 5\}$

$$P(\text{getting an odd number}) = \frac{n(E)}{n(S)} = \frac{3}{6} = \frac{1}{2}$$

2. A coin is tossed twice .find the probability of getting at least one head.

Solution:

Here $S = \{HH, HT, TH, TT\}$

$E = \{HT, TH, HH\}$

$$P(\text{getting at least one head}) = \frac{n(E)}{n(S)} = \frac{3}{4}$$

3. A number a is chosen at random from the numbers 4, 6, 1, 92, 32, 56, 98, 11, 55. What is the probability that $a < 50$.

Solution:

Here $S = \{4, 6, 1, 92, 32, 56, 98, 11, 55\}$

$E = \{4, 6, 1, 32, 11\}$

$$P(\text{choosing } a < 50) = \frac{n(E)}{n(S)} = \frac{5}{9}$$

4. Two dice are thrown simultaneously. Find the probability of getting a sum greater than or equal to 8 on adding the two faces.

Solution:

Here $S = \{(1,1)(1,2)(1,3)(1,4)(1,5)(1,6)$

$(2,1)(2,2)(2,3)(2,4)(2,5)(2,6)$

$(3,1)(3,2)(3,3)(3,4)(3,5)(3,6)$

$(4,1)(4,2)(4,3)(4,4)(4,5)(4,6)$

$(5,1)(5,2)(5,3)(5,4)(5,5)(5,6)$

$(6,1)(6,2)(6,3)(6,4)(6,5)(6,6)\}$

$E = \{(2,6)(3,5)(3,6)(4,4)(4,5)(4,6)(5,3)(5,4)(5,5)(5,6)(6,2)(6,3)(6,4)(6,5)(6,6)\}$

$$P(\text{getting a sum greater than or equal to 8}) = \frac{n(E)}{n(S)} = \frac{15}{36}$$

5. Tickets numbered 1 to 25 are mixed up and then a ticket is drawn at random. What is the probability that the ticket drawn has a number which is multiple of 3 or 5?

Solution:

Here $S = \{1, 2, 3, \dots, 24, 25\}$

$E =$ Event of getting a multiple of 3 or 5 = $\{3, 6, 9, 12, 15, 18, 21, 24, 5, 10, 20, 25\}$

$$P(E) = \frac{n(E)}{n(S)} = \frac{12}{25}.$$

II. LOGICAL REASONING

Unit - 1 : Analogy basing on kinds of relationships, Simple Analogy; Pattern and Series of Numbers, Letters, Figures. Coding-Decoding of Numbers, Letters, Symbols (Figures), Blood relations

1. Analogy

Definition : An analogy compares the relationship between two things or ideas to highlight some point of similarity. It is a way to clarify an idea or an unfamiliar concept by comparing it to something familiar.

Look at this example:

appalling : pleasing :: interesting : _____

A. amusing
B. engaging
C. enthralling
D. boring



NOTE :

- The example given above asks you to identify the relationship between pairs of words.
- To answer this question, you must first decode the symbols. The colon (:) stands for the phrase “is related to,” and the double colon (::) can be read as “in the same way that.” Thus, you would read the above example like this: “Appalling is to pleasing in the same way that interesting is to...”
- To figure out the missing word, you need to identify the relationship between the first two elements precisely as possible, and choose a word that will make the final pair have a parallel relationship.
- Most accurately, you might describe the relationship between appalling and pleasing as “appalling is an antonym of pleasing.”
- Now read the first word of the second pair, supplying the same relationship: “interesting is an antonym of...”
- The only word that fits this blank adequately is “boring,” the opposite of ‘interesting’. The other three options do not fit the blank as they are the synonyms of interesting.
- In the example above, the relationship between the words in the first pair is compared to the relationship of words in the second pair. This is what we call an analogy is.

For example - **butterflies : swarm :: fish : school**



You can read this analogy as:

Butterflies are to swarm as fishes are to school.

In this example, swarm is the specific term for a group of butterflies. Similarly, school is the specific term for a group of fish.

Both the pairs of words in the analogy illustrate the same relationship.

KINDS OF RELATIONSHIPS

1. Instrument and measurement

- Ex-Barometer : Pressure - Barometer is an instrument used to measure pressure.
- Some more examples -
- Thermometer : Temperature
- Odometer : Speed
- Scale : Length
- Balance : Weight
- Rain gauge : Rain

2. Quantity and Unit -

- Ex- Length : Metre - Metre is the commonly used unit of length.
- Some more examples –
- Mass : Kilogram
- Force : Newton
- Volume : Litre
- Time : Hour
- Temperature : Degrees

3. Individual and group -

- Ex – Sailors : Crew - A group of sailors is called a crew.
- Some more examples –
- Cattle : Herd
- Flowers : Bouquet
- Grapes : Bunch
- Singer : Chorus
- Man : Crowd

4. Animal and young one –

- Ex – Horse : Pony - Pony is the young one of horse.
- Some more examples –
- Cat : Kitten
- Sheep : Lamb
- Cow : Calf
- Dog : Puppy
- Man : Child

5. Male and female –

- Ex- Horse : Mare - Mare is the female horse.
- Some more examples –
- Dog : Bitch
- Son : Daughter
- Lion : Lioness
- Gentleman : Lady
- Nephew : Niece

6. Individual and class –

- Ex – Lizard : Reptile - Lizard belongs to the class of reptiles.
- Some more examples
- Man : Mammal
- Ostrich : Bird
- Butterfly : Insect
- Snake : Reptile
- Whale : Mammal

7. Individual and dwelling places

- Ex – Dog : Kennel - A dog lives in a kennel.
- Some more examples –
- Bee : Apiary
- Cattle : Shed
- Lion : Den
- Poultry : Farm
- Fish : Aquarium

8. Study and topics –

- Ex – Ornithology : Birds - Ornithology is the study of birds
- Some more examples –
- Botany : Plants
- Entomology : Insects
- Zoology : Animals
- Oology : Eggs
- Virology : Viruses

9. Worker and tool –

- Ex – Carpenter : Saw - Saw is a tool used by the carpenter.
- Some more examples –
- Woodcutter : axe
- Tailor : needle
- Soldier : gun
- Doctor : stethoscope
- Farmer : plough

10. Tool and action –

- Ex- Needle : Sew - A needle is used for sewing
- Some more examples –
- Knife : cut
- Pen : write
- Spoon : feed
- Gun : shoot

- Axe : grind

11. Worker and working place-

- Ex – Chef : Kitchen - A chef works in a kitchen
- Some more examples –
- Farmer : field
- Warrior : battlefield
- Teacher : school
- Doctor : hospital
- Clerk : office

12. Worker and product –

- Ex – Mason : Wall - A mason builds a wall.
- Some more examples –
- Farmer : crop
- Hunter : prey
- Carpenter : furniture
- Author : book
- Butcher : meat

13. Product and Raw Material-

- Ex-Prism: Glass- Prism is made of glass.
- Some more examples –
- Butter : Milk
- Wall : Brick
- Furniture : Wood
- Shoes : Leather
- Oil : Seed

14. Part and whole relationship –

- Ex- Pen : Nib - Nib is a part of a pen
- Some more examples –
- Pencil : lead
- House : keychain

- Fan : blade
- Class : student
- Room : Window

15. Word and Intensity -

- Ex- Anger: Rage- Rage is of higher intensity than anger.
- Some more examples –
- Wish: Desire
- Kindle: Burn
- Sink: Drown
- Quarrel: War
- Error: Blunder

16. Word and Synonym –

- Ex- Abode : Dwelling – Abode means the same as dwelling. Thus, dwelling is the synonym of abode.
- Some more examples –
- Ban : Prohibition
- Assign : Allot
- Vacant : Empty
- House : Home
- Flaw : Defect

17. Word and Antonym-

- Ex- Attack : Defend – Defend means the opposite of attack. Thus, Defend is the antonym of Attack
- Some more examples –
- Advance : Retreat
- Cruel : kind
- Best : Worst
- Fresh : Stale
- Ignore : Notice

Examples –

In the following questions, find out the RELATION between given two words in capital letter and pick up one word proportionately from the options that bear the same relation.

1. Day: Night :: _____ : _____
(1) Half : Full (2) Tall : Fat
(3) East : West (4) Food : Vegetable

Answer - East : West (Opposite To Each Other).

2. Distance: Mile :: _____ : _____
(1) Weight : Scale (2) Fame : Television
(3) Field : Plough (4) Liquid: Litre

Answer - Liquid : Litre (2nd one is the unit of 1st one).

3. Ring: Finger :: Shoe : _____
(1) Socks (2) Case
(3) Foot (4) Market

Answer - Foot (2nd one is the body part in which the 1st one is worn)

4. Court: Justice :: School : _____
(1) Teacher (2) Education
(3) Student (4) Discipline

Answer - Education (The thing that is imparted in the institution).

5. Mouse: Cat :: Worm : _____
(1) Trap (2) Bird
(3) Paw (4) Grab

Answer - Bird (Prey : Predator)

2. SERIES

➤ NUMBER SERIES –

A series of numbers which follow a certain pattern throughout.

Case I –

Finding the difference between the terms in the given series –

Ex 1 : Which number would replace ‘ ? ’ in the series : 7 , 12 , 19 , ? , 39

a) 29 b) 28 c) 26 d) 24

Solution - Difference between 7 and 12 = 5

Difference between 12 and 19 = 7

Note – Here the difference increases by 2 , so the next difference should be 9.

Thus, answer = $19 + 9 = 28$.

Ex 2 : Which is the number that comes next in the sequence : 0 , 6 , 24 , 60 , 120 , 210 ?

a) 240 b) 290 c) 336 d) 504

Solution – Pattern of the series ; $1^3 - 1$, $2^3 - 2$, $3^3 - 3$, $4^3 - 4$, $5^3 - 5$, $6^3 - 6$

Next number $7^3 - 7 = 343 - 7 = 336$

Hence, the answer is 336.

Ex 3 : Which is the number that comes next in the following sequence : 4 , 6 , 12 , 14 , 28 , 30 , ?

a) 32 b) 60 c) 62 d) 64

Solution – The given sequence is the series 4, 4+2 (=6), 6*2 (=12), 12+2, 14*2, 28+2...

So pattern followed is +2,*2,+2,*2,

So, next number is 30*2

Hence, answer = 60

Ex 4 : Find out the missing number in the following sequence : 1 , 3 , 7 , ? , 21

a) 10 b) 11 c) 12 d) 13

Solution - Pattern followed is + 2 , + 4 ,

Missing number = $7 + 6 = 13$

Hence, answer = 13.

Ex 5 : Which fraction comes in the sequence $\frac{1}{2}$, $\frac{3}{4}$, $\frac{5}{8}$, $\frac{7}{16}$, ?

a) $\frac{9}{32}$

b) $\frac{10}{17}$

c) $\frac{11}{34}$

d) $\frac{12}{35}$

Solution- The numerators of the fractions in the series have a difference of 2. The denominators of the fractions form the series 2,4,8,16 i.e $2^1, 2^2, 2^3, 2^4$...So the numerator of the next fraction will be $7+2=9$ and denominator will be $2^5=32$.

Answer = $\frac{9}{32}$

Elementary Idea of Progressions

1. Arithmetic Progression (A.P)- The progression of the form $a, a+d, a+2d, \dots$ is known as AP with first term = a and common difference = d

Ex 1- 3, 6, 9, 12,..... is an AP with $a=3, d=6-3=3$

In an AP we have n th term = $a + (n-1)d$

Ex 2- In the series 357, 363, 369,....., What will be the 10th term ?

a) 405 b) 411 c) 413 d) 417

Solution- The given series is an A.P in which $a=357, d=6$

$$\begin{aligned}10^{\text{th}} \text{ term} &= a+(10-1)d \\ &= a+9d \\ &= (357+9 \times 6) \\ &= 357+54 \\ &= 411\end{aligned}$$

Ex3- How many terms are there in the series 201, 208, 215, ..., 369 ?

A) 23 b) 24 c) 25 d) 26

Solution- The given series is an AP in which $a=201, d=7$

Let the number of terms be n .

$$\begin{aligned}369 &= 201 + (n-1) \times 7 \\ \Rightarrow 369 &= 201 + 7n - 7 \\ \Rightarrow 168 &= 7n - 7 \\ \Rightarrow 7n &= 175 \\ \Rightarrow n &= 25 \\ \text{Answer} &= 25\end{aligned}$$

2. Geometric Progression (G.P)- The progression of the form a, ar, ar^2, ar^3, \dots is known as GP with first term = a and common ratio = r

Ex 1- 1, 5, 25, 125, is a GP with $a = 1$ and $r = \frac{5}{1} = \frac{25}{5} = \dots = 5$

In a GP we have n th term = ar^{n-1}

Ex 2- In the series 7, 14, 28,..... What will be the 10th term?

a) 1792 b) 2456 c) 3584 d) 4096

Solution- Clearly, $7 \times 2 = 14, 14 \times 2 = 28, \dots$ and so on

In the given series of GP $a=7, r=2$

$$\begin{aligned}10^{\text{th}} \text{ term} &= ar^{(10-1)} \\ &= ar^9 \\ &= 7 \times 2^9 \\ &= 7 \times 512 \\ &= 3584\end{aligned}$$

Answer= 3584

Ex 3- Find the number of terms in GP 6, 12, 24,, 1536 ?

- a) 7 b)9 c)8 d)10

Solution- $a_1 = 6$ $a_2 = 12$ $a_n = 1536$

$$r = \frac{a_2}{a_1} = \frac{12}{6} = 2$$

Now we have, $1536 = ar^{n-1}$

$$\Rightarrow 1536 = 6 \times 2^{n-1}$$

$$\Rightarrow 256 = 2^{n-1}$$

$$\Rightarrow 2^8 = 2^{n-1}$$

$$\Rightarrow 8 = n-1$$

$$\Rightarrow n = 9.$$

➤ LETTER SERIES

In this series, only letters are available which follow a certain pattern throughout.

Position of Letters

1	2	3	4	5	6	7	8	9	10	11	12	13
↕	↕	↕	↕	↕	↕	↕	↕	↕	↕	↕	↕	↕
A	B	C	D	E	F	G	H	I	J	K	L	M
26	25	24	23	22	21	20	19	18	17	16	15	14
↕	↕	↕	↕	↕	↕	↕	↕	↕	↕	↕	↕	↕
Z	Y	X	W	V	U	T	S	R	Q	P	O	N

Quick tricks :

1. Starting point of the series is called left end and end point of the series is called right end.
2. To solve the question easily we should break the series in combination of 5-5 elements – ABCDE / FGHIJ / KLMNO / PQRST / UVWXY / Z - it will help in counting the letters.
3. There are some key words which help in remembering the place values of the letters. Once the candidate knows the position of alphabets, he requires to learn time management.

TABLE OF 3

$\begin{matrix} 3 \\ \downarrow \\ C \end{matrix}$	$\begin{matrix} 6 \\ \downarrow \\ F \end{matrix}$	$\begin{matrix} 9 \\ \downarrow \\ I \end{matrix}$	$\begin{matrix} 12 \\ \downarrow \\ L \end{matrix}$	$\begin{matrix} 15 \\ \downarrow \\ O \end{matrix}$	$\begin{matrix} 18 \\ \downarrow \\ R \end{matrix}$	$\begin{matrix} 21 \\ \downarrow \\ U \end{matrix}$	$\begin{matrix} 24 \\ \downarrow \\ X \end{matrix}$
$\begin{matrix} 5 \\ \downarrow \\ E \end{matrix}$	$\begin{matrix} 10 \\ \downarrow \\ J \end{matrix}$	$\begin{matrix} 15 \\ \downarrow \\ O \end{matrix}$	$\begin{matrix} 20 \\ \downarrow \\ T \end{matrix}$	$\begin{matrix} 25 \\ \downarrow \\ Y \end{matrix}$			

TABLE OF 5

Words given above are the arrangement of alphabets having position multiples of 3 in first line and 5 in second line.

4. The opposite letters

A ↔ Z (AZ ad)	F ↔ U (FU ll)	K ↔ P (Ka n Pu r)
B ↔ Y (Bo Y)	G ↔ T (GT road)	L ↔ O (LO ve)
C ↔ X (Cru X)	H ↔ S (Hi gh S chool)	M ↔ N (Ma N)
D ↔ W (De W)	I ↔ R (Indi an Ra ilway)	
E ↔ V (EV en)	J ↔ Q (Jun gle Q ueen)	

Examples –

1. Solve the series : JAF, JEF, JIF, JOF, ?

- a) PIG b) PET c) JUF d) POT

Solution –

The middle letters which are vowels have an increasing trend of A, E, I, O, U and remaining letters have been retained as it is. So answer would be **JUF**.

2. Solve the series - WXCD, UVEF, STGH, QRIJ?

- a) OPKL b) AYBZ c) JIRQ d) LRMS

Solution –

The last two letters of every word is in ascending order and the first two letters are in descending order.

OP precedes QR and KL succeeds IJ.

Answer - **OPKL**

3. In the word EMASCULATE let the place value of the letters according to English alphabets be written in descending order then which number is 4th from the left end?

- a. 13 b.14 c.12 d.1

Solution –

E	M	A	S	C	U	L	A	T	E
5	13	1	19	3	21	12	1	20	5

Descending order -

21 20 19 **13** 12 5 5 3 1 1

So, answer is 13 , 4th from left end.

4. If only each of the vowels in the word IMPOSE is changed to the next letter in the English alphabet then which of the following will be the fifth letter from the left end ?

- a) P b) J c) F d) S

Solution -

I	M	P	O	S	E
J	M	P	P	S	F

So, the answer is S

➤ **FIGURE SERIES**

Definition – In a figure series, there is a sequence of figures depicting a change step by step. Either one of these figures is out of order and has to be omitted or figure has to be selected from a separate set of figures which would continue the series.

There are two directions mostly used in the figures – i) clockwise direction ii) anti – clockwise direction. A clockwise direction movement will be as in a square boundary.

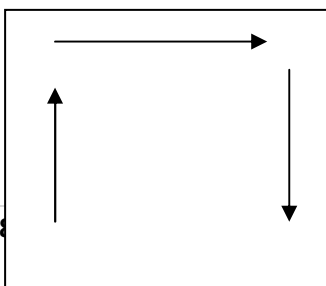



Fig - A clockwise direction movement in a square boundary.

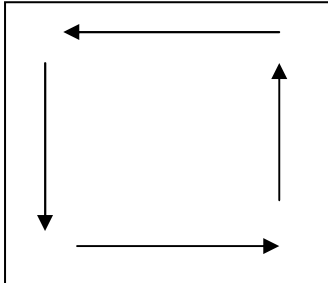

Fig – An anticlockwise direction movement in a square boundary.

Note – In a square boundary means a square box.

Four Figure series –

In this case , the series or sequence is indicated by four problem figures and it is required to select a figure from amongst the answer figures which would be fifth figure to continue the series.

Examples –

1. Find the figure that will replace the question mark

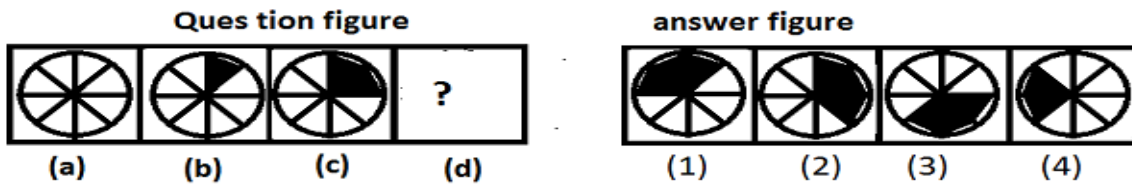

Answer - Option (2)

The sequence of this series is that the circle has been divided into various sectors which are getting shaded in clockwise direction by adding a cord each time.

2. Which figure can be placed in place of question mark?

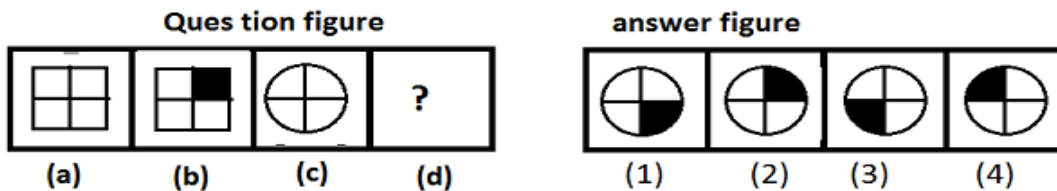

Answer – Option (2)

Figure (a) and (b) are related to each other by getting shade of upper right side quarter therefore in this way figure (2) will make pair with figure (c).

3. Find the similar figure as that of the question figure.

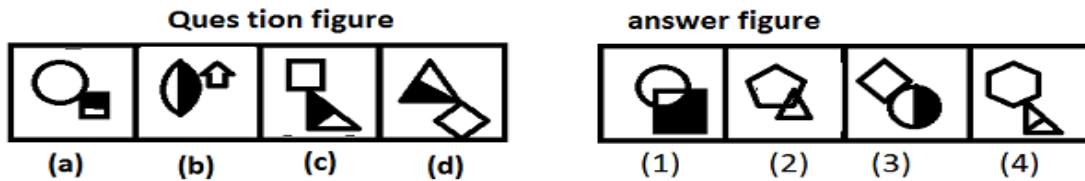

Answer – Figure (3)

In question figure all blocks consist of two figures touching each other and half of any of them is shaded. The sequence in the question figure also shows that in the odd number blocks, top figure is empty and bottom is shaded while in the even number blocks top figure is shaded while the bottom one is empty. Hence figure (3) is same as question figure.

4. If the figures continue to change in the same order what should the fifth figure be?"

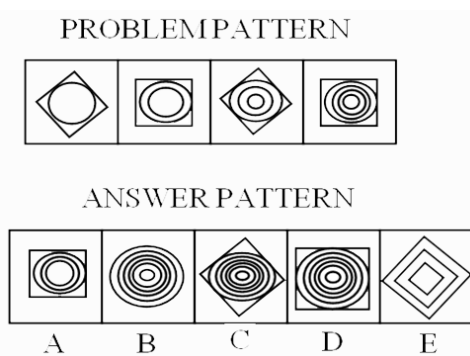

Solution: You will see two different things happening here. The number of circles is increasing 1, 2, 3, 4, so that the next figure would have 5 circles. But note that the square is also turning. First the point is up, then the flat side, then again the point is up, and then again the flat side. In the next place, therefore, the point should be up. But in figure C there are 6 circles inside the rectangle.

Answer: So none of the figure is correct.

5. Continue the series :

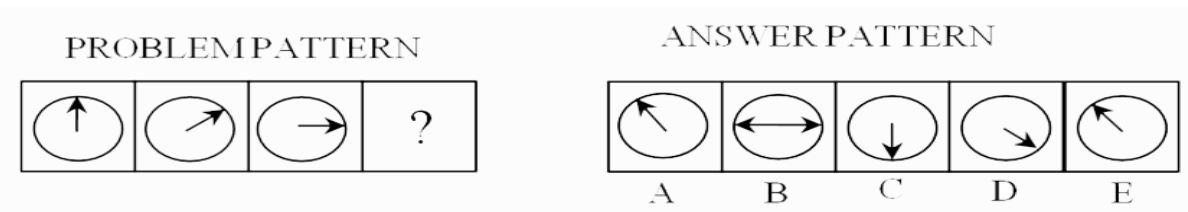

Answer – D .

Sol: Here the arrow in the circle goes on rotating in clockwise direction at an angle of 45° each time. Hence the answer would be (d).

Five figure series:

In this case , the series or sequence is indicated by five problem figures and it is required to select a figure from amongst the answer figures which would be sixth figure to continue the series.

Examples –

1. Select a figure from amongst the answer Figures which will continue the same series as established by the five Problem Figures.

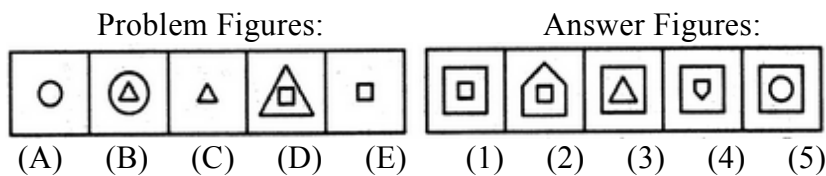

Answer: Option (4)

In one step, the existing element enlarges and a new element appears inside this element. In the next step, the outer element is lost.

2. Select a figure from amongst the Answer Figures which will continue the same series as established by the five Problem Figures.

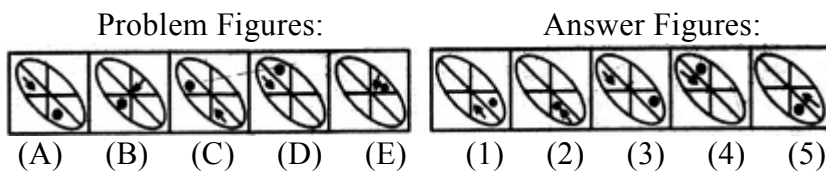

Answer : Option (1)

In each step, the dot moves one space clockwise and the arrow moves two spaces clockwise.

3. Select a figure from amongst the Answer Figures which will continue the same series as established by the five Problem Figures.

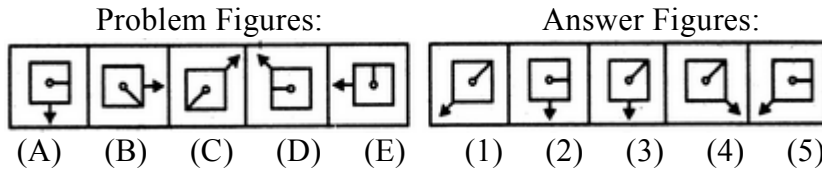

Answer - Option **(3)**

The pin rotates 45° clockwise and 90° clockwise alternately and moves one space (each space is equal to half-a-side of the square) and two spaces clockwise alternately. The arrow rotates 90° anti clockwise and 45° anti clockwise alternately and moves two spaces and one space.

4. Select a figure from amongst the Answer Figures which will continue the same series as established by the five Problem Figures.

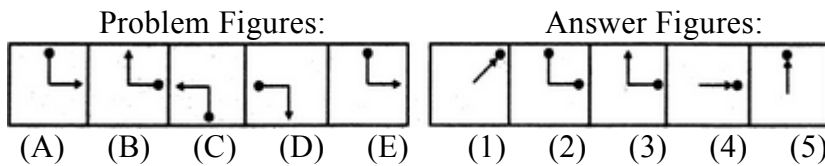

Answer - Option **(3)**

In each step, the pin rotates 90° clockwise and the arrow rotates 90° anti clockwise.

5. Select a figure from amongst the Answer Figures which will continue the same series as established by the five Problem Figures.

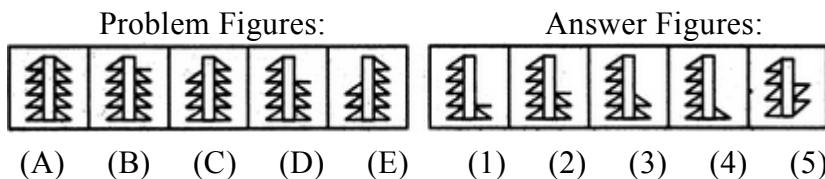

Answer – Option **(2)**

In one step, the figure gets laterally inverted and one line segment is lost from the upper end of the RHS portion of the figure. In the next step, the figure gets laterally inverted and one line segment is lost from the upper end of the LHS portion of the figure.

\

3. CODING & DECODING

- **Coding** is a process in which a word, a number, or a series of combination of words and numbers is expressed in a particular code or pattern based on various rules. You have to answer the questions based on these set of rules.
- **Decoding** is the process of (interpreting) deciphering the coded pattern and reverting it to its original form from the given codes. Hence, you are required to understand the logic behind the coding pattern and then apply this logic to find answers.

LETTER CODING:

Here letters are assigned codes according to a set pattern or rule concerning the movement or reordering / rearranging of letters and you need to detect this rule to decode a message. Sometimes, specific codes are assigned to particular letters without any set pattern. Observe a few examples to know the various reordering or rearranging techniques.

Ex-1

In a code language if TRAINS is coded as RTIASN, how PISTOL will be coded in the same language?

- (a) SITLOP
- (b) IPSTLO
- (c) SIPTLO
- (d) IPTSLO

Solution: (Answer – d)

If we compare the basic word {TRAINS} with the coded word {RTIASN}, we would see that the letters used in the word are same as in the basic word but their order of placement has been changed. Letter T at first position of the basic word has been placed at second position in the coded word and the letter R at the second position has been placed in the first position.

It means that in this question, letters of the basic word have been interchanged i.e. first letter with second, third with the fourth and so on. And thus we get the coded word. So PISTOL will be coded as IPTSLO. Hence option (d) is the answer.

Ex-2

In a certain code, TEACHER is written as VGCEJGT. How is CHILDREN written in that code?

- (a) EJKNEGTP
- (b) EGKNFITP
- (c) EJKNFGTO
- (d) EJKNFTGP

Solution: (Answer- d)

Each alphabet in the word "TEACHER" is moved two steps forward to obtain the corresponding alphabet of the code.

T E A C H E R

V G C E J G T

(Each alphabet is increasing by 2)

Similarly, we have

C H I L D R E N

E J K N F T G P

Ex-3

In a certain code language, the word ROAD is written as WTFI. Following the same rule of coding, what should be the word for the code GJFY?

(a) REAP (b) TAKE (c) BEAT (d) LATE

Solution: (Answer- c)

Each alphabet of the word is five steps behind the corresponding alphabet of the given code word.

Hence, BEAT is coded as GJFY.

Ex-4

If 'tee see pee' means 'drink fruit juice'; 'see kee lee' means 'juice is sweet' and 'lee ree mee' means 'he is intelligent', which word in that language means 'sweet'?

- (a) see
- (b) kee
- (c) lee
- (d) pee

Solution: (Answer b)

In the first and second statement, the common word is 'juice' and the common code word is 'see'. So, 'see' means 'juice'.

In the second and third statements, the common word is 'is' and the common code is 'lee'. So 'lee' means 'is'. Thus in the second statement, the remaining word 'sweet' is coded as 'kee'. Hence the answer is choice (b).

NUMBER CODING:

Numerical code is given or value is assigned to a word. Here the only way to relate the alphabets & numbers is by associating the positions of the letters in the English alphabet. Sometimes any mathematical operation like addition or subtraction can be performed using the position of the letters. Direct coding questions can also be asked.

Ex-1 If PAINT is coded as 74128 and EXCEL is coded as 93596, then how would you encode ACCEPT?

- (a) 455978
- (b) 547978
- (c) 554978
- (d) 735961

Solution: (Answer- a)

In the given code the alphabets have been coded as follows:

P	A	I	N	T	E	X	C	E	L
7	4	1	2	8	9	3	5	9	6

So, in ACCEPT, A is coded as 4, C as 5, E as 9, P as 7 and T as 8. Hence the correct code is 455978 and therefore the answer is Choice (a).

Ex-2 If DELHI is coded as 73541 and CALCUTTA as 82589662, how can CALICUT be coded ?

- a. 5279431
- b. 5978213
- c. 8251896
- d. 8543691

Solution.(Answer: c)

The alphabets are coded as follows :

D	E	L	H	I	C	A	U	T
7	3	5	4	1	8	2	9	6

So, in CALICUT,

C is coded as 8,

A as 2,

L as 5,

I as 1,

U as 9 and

T as 6.

Thus, the code for CALICUT is 8251896.

Ex-3 If in a certain code, TWENTY is written as 863985 and ELEVEN is written as 323039, how is TWELVE written in that code ?

- a) 863203
- b) 863584
- c) 863903
- d) 863063

Solution (Answer: a)

The alphabets are coded as shown :

T	W	E	N	Y	L	V
8	6	3	9	5	2	0

So, In TWELVE ,

T is coded as 8,

W as 6,

E as 3,

L as 2,

V as 0.

Thus, the code for TWELVE is 863203.

Ex-4 In a certain code 'MISSIONS' is written as 'MSIISNOS'. How is 'ONLINE' written in that code?

1. OLNNE
2. ONILEN
3. NOILEN
4. LNOENI
5. ONNLIE

Solution: Answer - Option 1

Explanation: First and last letter remain same. The others interchange their positions in pair of two.

So, NL become LN and IN become NI so code of ONLINE will be OLNNE.

SYMBOL CODING

Directions (Q1-5): In each of the following questions, there is a group of letters followed by four combinations of digits/symbols (A), (B), (C) and (D). You have to find out which of the combinations correctly represents the group of letters based on the following digits/symbol coding system and the conditions those follow and mark the number of that combination as the answer. If none of the combinations is correctly represents the group of letters then mark (E).

Letter:	L	H	U	B	E	P	N	A	K	I	R	S	T	M	V
Digits/Symbols:	5	<	4	#	@	3	*	^	8	%	9	!	~	1	\$

Conditions:

- i) If the first letter is a vowel and the last letter is a consonant, then the codes are to be interchanged.
- ii) If both the first and the last letters are vowels, then both are to be coded as the code for the last letter
- iii) If any word has more than two vowels, then all vowels are coded to be as the code for I.

Q.1 UNRBV

- A. 4*9#\$
- B. \$*9#\$
- C. \$*9#4
- D. \$*4#9
- E. None of these.

Ans. C

Solution: UNRBV - \$*9#4 (Condition i)

Q.2 SMALKI

- A. %15!8^
- B. !1^58%
- C. 1#!568
- D. !1^5%8
- E. None of these

Ans. B

Solution: SMALKI - !1^58%

Q.3 AMBLPU

- A. ^5#34^
- B. 1#543^
- C. ^1#534
- D. 41#534
- E. None of these

Ans.D

Solution: AMBLPU - 41#534 (Condition ii)

Q.4 KINAHE

- A. 9*#%15
- B. 8%*%<%
- C. @*%\$56
- D. %^85@1
- E. None of these

Ans.B

Solution: KINAHE - 8%*%<% (Condition iii)

Q.5 EMKLVP

- A. \$5&58^
- B. \$5&^85
- C. @1853\$
- D. 3185\$@
- E. None of these

Ans.D

Solution: EMKLVP - 3185\$@ (Condition i)

4. BLOOD RELATIONS

Definition- A person who is related to another by birth rather than by marriage.

NOTE- Relation on the mother side is called **maternal** and that on the father side is called **paternal** and if the relation is on the partner side (Husband or wife) is called **in-law**.

A method known as **FAMILY TREE** is used to solve the questions regarding blood relation which is just a graphical method to show all the possible relation.



Used for males



Used for females

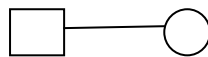

Husband wife relationship

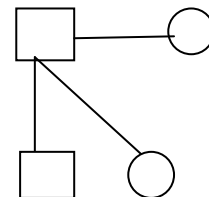

Son and daughter

Indirect Reference	The real relation
Father's or Mother's Daughter	Sister
Father's or Mother's Son	Brother
Father's or Mother's Sister	Aunt
Father's or Mother's Brother	Uncle
Father's or Mother's Mother	Grandmother
Father's or Mother's Father	Grandfather
Daughter's Husband	Son-in-law
Son's Wife	Daughter – in – law
Husband's or Wife's Brother	Brother – in – law
Husband's or Wife's Sister	Sister – In – law
Brother's Daughter	Niece
Brother's Son	Nephew
Brother's Wife	Sister-in-law
Sister's Husband	Brother- in- law
Aunt's or Uncle's Son or Daughter	Cousin
Granddaughter's or Grandson's daughter	Great grand daughter

The first step to being able to solve blood relation questions is a logical reasoning of the relations that exist between different members of a family, both close and far.

EXAMPLES

Question 1: Pointing to a girl in the photograph, Ajay said, "Her mother's brother is the only son of my mother's father." How is the girl's mother related to Ajay ?

- A) Mother
- B) Sister
- C) Aunt
- D) Grandmother
- E) None of these

Solution:

Only son of Ajay's mother's father -- Ajay's maternal uncle.

So, the girl's maternal uncle is Ajay's maternal uncle.

Thus, the girl's mother is Ajay's aunt.

Question 2:

1. $A + B$ means A is the brother of B

2. $A \times B$ means A is the father of B

3. $A \div B$ means A is the mother of B

Which of the following would mean "G is the son of H"?

A) $H \times I \times G$

B) $H + G \times I$

C) $H \div G \div I$

D) $H \times G + I$

Solution: Answer: Option D

Go by options. In fourth option, our diagram will be like

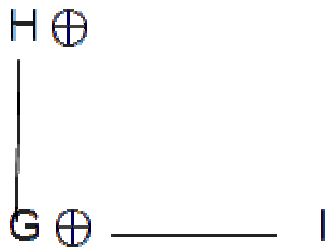

We don't know the gender of I. So. We will not put any symbol on its side.

Question 3. A is B's sister. C is B's mother. D is C's father. E is D's mother. Then, how is A related to D?

A. Grandfather

B. Grandmother

C. Daughter

D. Granddaughter

Answer: D) Granddaughter

Explanation:

A is the sister of B and B is the daughter of C.

So, A is the daughter of C. Also, D is the father of C.

So, A is the granddaughter of D.

Question 4. P is the brother of Q and R. S is R's mother. T is P's father. Which of the following statements cannot be definitely true ?

A. T is Q's father

B. S is P's mother

C. P is S's son

D. Q is T's son

Answer: D) Q is T's son

Explanation:

P, Q, R are children of same parents. So, S who is R's mother and T, who is R's father will be mother and father of all three.

However, it is not mentioned whether Q is male or female So, D cannot be definitely true.

Question 5. Pointing to a person, a man said to a woman, "His mother is the only daughter of your father." How was the woman related to the person ?

A. Aunt

B. Mother

C. Wife

D. Daughter

Answer: A) Aunt

Explanation:

Daughter of your father — your sister. So, the person's mother is woman's sister or the woman is person's aunt.

UNIT – 2 : Logical Statements – Two premise argument, More than two premise argument using connectives

In logic, any statement is termed as the Proposition. Thus a proposition is a statement expressing certain relation between two or more terms, analogous to a sentence in grammar.

The proposition consists of three parts:

- Subject-The subject is that about which something is said
- Predicate-The predicate is the part of the proposition denoting that which is affirmed or denied about the subject.
- Copula-The copula is that part of the proposition which denotes the relation between the subject and the predicate.
- Consider the proposition(‘Man is cultured’)
Here ‘man’ is the subject.
‘Cultured’ is the quality affirmed for this subject. So it is the predicate.
‘is’ denotes the relation between the subject and the predicate. So it is the copula.

FOUR FOLD CLASSIFICATION OF PROPOSITIONS:

a. Universal Affirmative Proposition

Example-All lions are animals.

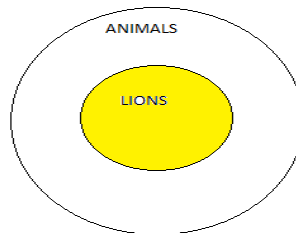

From this, we cannot say ‘All animals are lions.’

b. Universal Negative Proposition

Ex. - No child is intelligent by birth.



c. Particular Affirmative Proposition

Ex. - Some people are foolish.

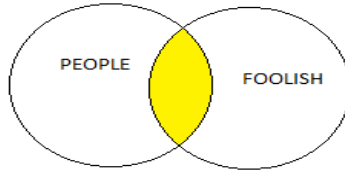

Here the subject term ‘Some People’ is used not for all but only for some people and similarly the predicate term ‘Foolish’ is affirmed for a part of the subject.

d. Particular Negative Proposition

e.g. “ Some animals are not wild ”

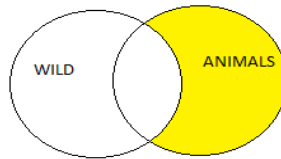

Here the subject term ‘ some animals’ is used only for a part of its class while the predicate term ‘wild’ is not denied in entirety to the subject term.

These facts can be summarized as follows :

Proposition	Type
a) Universal Affirmative Proposition	All S is P.
b) Universal Negative Proposition	No S is P.
c) Particular Affirmative Proposition	Some S is P.
d) Particular Negative Proposition	Some S is not P.

SYLLOGISM:

Two premise argument

In Syllogism, a conclusion has to be drawn from two propositions , referred to as the Premises.

- Example 1–
- a. All lotus are flowers.
 - b. All flowers are beautiful.
 - c. All lotus are beautiful.

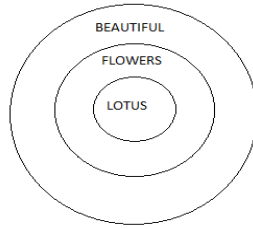

The propositions a) and b) are the Premises and the proposition c) is called the Conclusion which follows from the first two propositions.

Syllogism is concerned with 3 terms –

1. **Major term** : It is the predicate of the conclusion and is denoted by P .
2. **Minor term** : It is the subject of the conclusion and is denoted by S.
3. **Middle term** : It is the term common to both the premises and is denoted by M.

Example 2- Premises : 1. All dogs are animals.
2. Tiger is a dog.

Conclusion : Tiger is an animal.

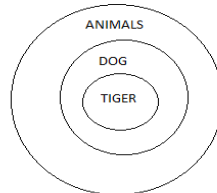

Rules for deriving the conclusion :

- I. The conclusion contain the middle term.

Example - Statements : 1. All men are girls.
2. Some girls are students.

Conclusion : 1. All girls are men.
2. Some students are girls.

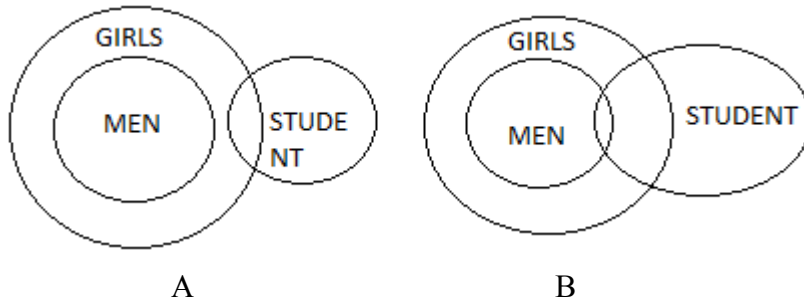

Here both the conclusions 1 and 2 contain the middle term 'girls'. From the above figures, It is clear that conclusion 1 does not follow, but conclusion 2 follows.

II. No term can be distributed in the conclusion unless it is distributed in the premises.

Example - Statements : 1. Some dogs are goats.

2. All goats are cows.

Conclusions : 1. All cows are goats.

2. Some dogs are cows.

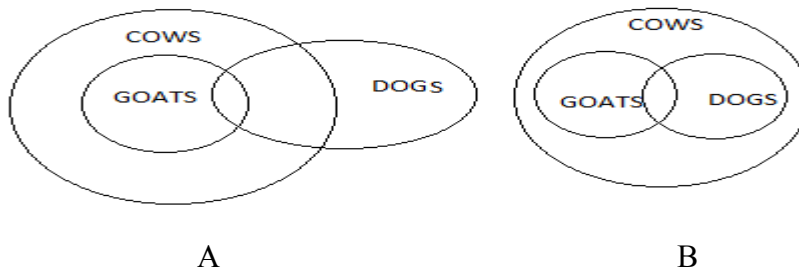

Statement 1 is an I type proposition which distributes neither the subject nor the predicate . Statement 2 is an A type proposition which distributes the subject i.e 'goats' only.

Conclusion 1 is an A type proposition which distributes the subject 'cow' only.

Since the term 'cow' is distributed in conclusion 1 without being distributed in the premises , so conclusion 1 cannot follow.

III. The middle term (M) should be distributed at least once in the premises. Otherwise, the conclusion cannot follow.

For the middle term to be distributed in a premise,

i) M must be the Subject if premise is an A proposition.

ii) M must be Subject or Predicate if premise is an E proposition.

iii) M must be Predicate if premise is an O proposition.

NOTE : In an I proposition, which distributes neither the subject nor the Predicate, the middle term cannot be distributed.

Example : Statements : 1. All fans are watches.

2. Some watches are black.

Conclusions : 1. All watches are fans.

2. Some fans are black.

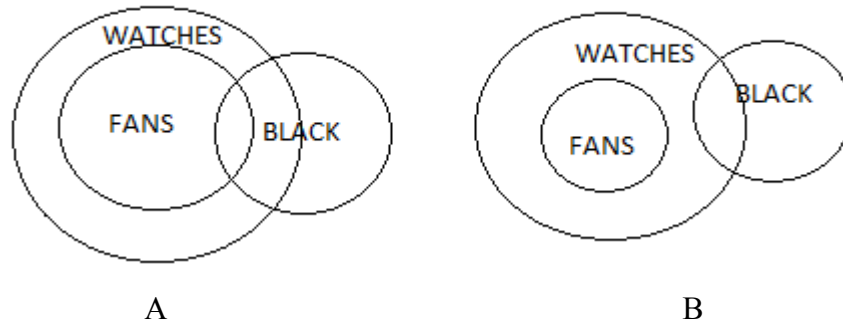

In the premises, the middle term is 'watches'. It is not distributed in the first premise which is an A proposition as it doesn't form its subject. Also, it isn't distributed in the second premise which is an I proposition. Since the middle term is not distributed at least once in the premises, so no conclusion follows.

IV. No conclusion follows

a) If both the premises are particular

Example : Statements : 1. Some books are pens.

2. Some pens are erasers.

Conclusions : 1. All books are erasers.

2. Some erasers are books.

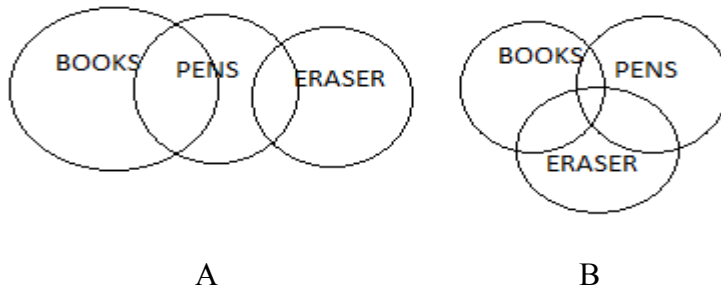

Since both the premises are particular, no conclusion follows.

b) If both the premises are negative

Example : Statements : 1. No flower is mango.

2. No mango is cherry.

Conclusions : 1. No flower is cherry.

2. Some cherries are mangoes.



Since both the premises are negative, neither conclusion follows.

c) If the major premise is particular and the minor premise is negative.

Example : Statements : 1. Some dogs are bulls.
2. No tigers are dogs.

Conclusions : 1. No dogs are tigers.
2. Some bulls are tigers.

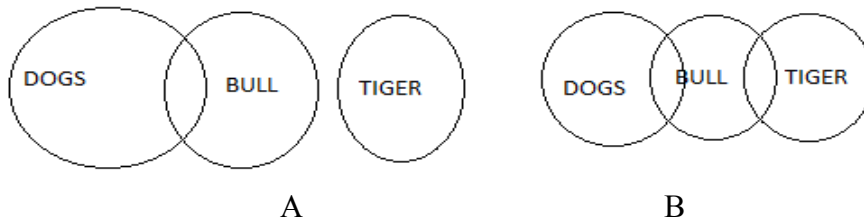

Here the first premise containing the middle term 'dogs' as the Subject is the major premise and the second premise containing the middle term 'dogs' as the Predicate is the minor premise. From the figure it is clear that conclusion 1 follows and conclusion 2 does not follow.

V. If the middle term is distributed twice, the conclusion cannot be universal.

Example: Statements : 1. All fans are chairs.
2. No tables are fans.

Conclusion : 1. No tables are chairs.
2. Some tables are chairs.

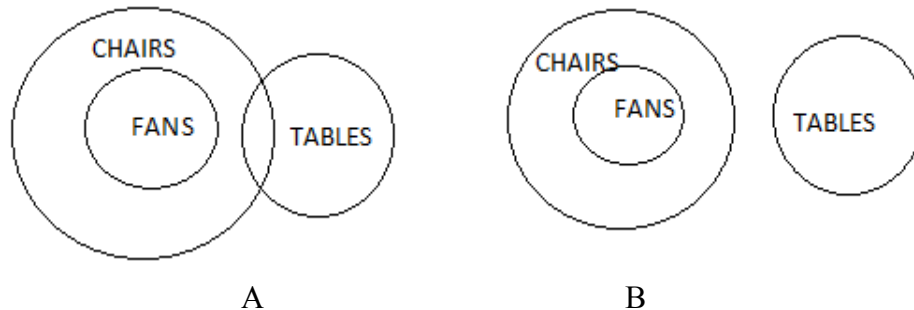

Here the first premise is an A proposition and so the middle term 'fans' forming the subject is distributed. The second premise is an E proposition and so the middle term

terms forming the predicate is distributed. Since the middle term is distributed twice so the conclusion cannot be universal.

VI. If one premise is negative, the conclusion must be negative.

- Example:
- | | |
|-------------|-----------------------------|
| Statements: | 1. All grasses are trees. |
| | 2. No tree is shrub. |
| Conclusion: | 1. No grasses are shrubs. |
| | 2. Some shrubs are grasses. |



Since one premise is negative the conclusion must be negative. So, only conclusion 1 follows and conclusion 2 cannot follow.

VII. If one is particular the conclusion is particular.

- Example:
- | | |
|-------------|-----------------------------|
| Statements: | 1. Some boys are thieves. |
| | 2. All thieves are dacoits. |
| Conclusion: | 1. Some boys are dacoits. |
| | 2. All dacoits are thieves. |

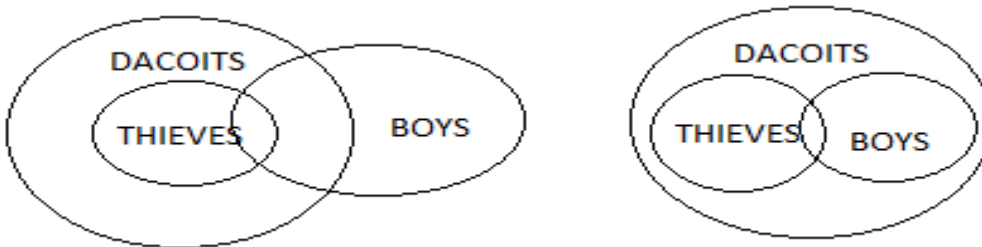

A

B

Since one premise is particular the conclusion must be particular. So, only conclusion 1 follows and conclusion 2 cannot follow.

VIII. If both the premises are affirmative, the conclusion would be affirmative. Example:

- | | |
|-------------|--------------------------------|
| Statements: | 1. All women are mothers. |
| | 2. All mothers are sisters. |
| Conclusion: | 1. All women are sisters. |
| | 2. Some women are not sisters. |

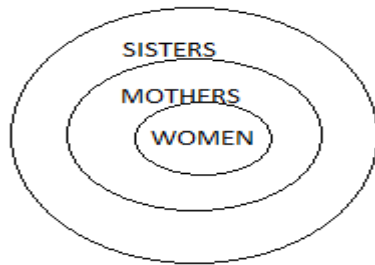

Since both premises are affirmative, the conclusion must be affirmative. So, only conclusion 1 follows and conclusion 2 cannot follow.

IX. If major premise be affirmative the conclusion must be particular.

Example: Statements: 1.All plays are stories.
2.Some poems are plays.
Conclusion: 1.Some poems are stories.
2.All stories are poems.

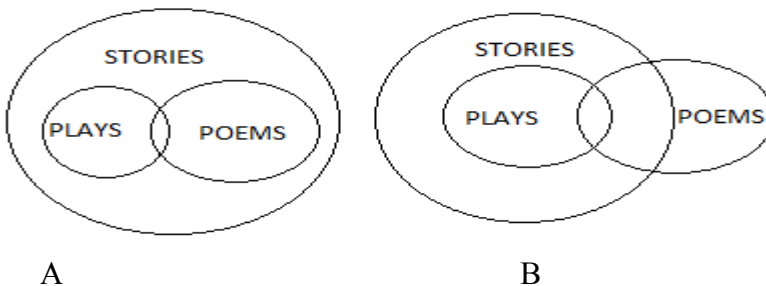

The first premise containing the middle term 'plays' as the subject is the major premise. Also, it is affirmative. So, the conclusion must be particular. So, only conclusion 1 follows and conclusion 2 cannot follow.

Example1: Which of the two conclusions can be concluded on the basis of given statements?

Statements: Some parrots are scissors.
Some scissors are not combs.

Conclusions: Some scissors are parrots.
Some combs are parrots.

Solution: Now, in this case, the possible conclusion is: Some scissors are parrots (I to I), as the universal principal no. 4 says, that with two particular statements only I to I is possible. Therefore, only 1 conclusion is possible. Nothing else is possible.

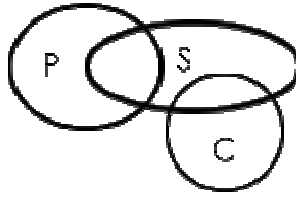

Example 2 : Which of the two conclusions can be concluded on the basis of given statements?

Statements: All flowers are candles.
All lanterns are candles.

Conclusions: Some flowers are lanterns.
Some candles are lanterns.

Solution:

Three possible diagrams are shown above for the given statements.

Conclusion I follows from last two possible solutions, but does not follow from the first possible solution. Therefore, this conclusion is false.

Conclusion II follows from all the three possible solutions.

Therefore, conclusion II is true.

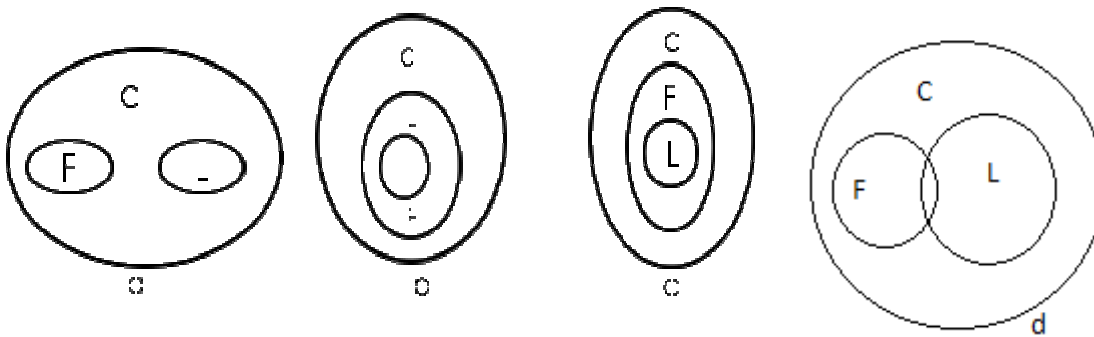

Example 3: Which of the two conclusions can be concluded on the basis of given statements?

Statements: All prisoners are men.
No man is educated.

Conclusions: All prisoners are uneducated.
Some men are prisoners.

Solution: Two possible diagrams are shown below for the given statements.

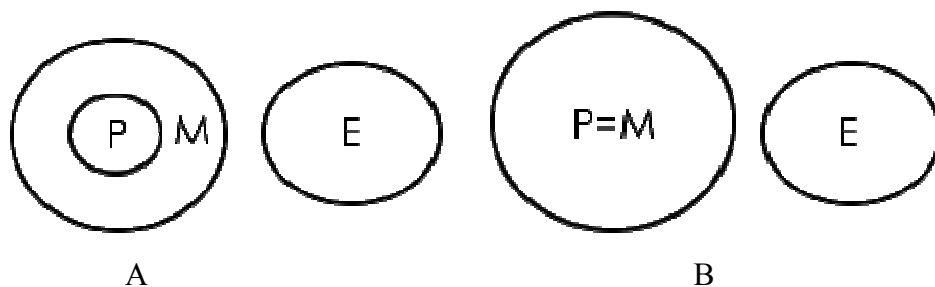

Conclusion I follows from both the possibilities, so conclusion I is true.
 Conclusion II also follows from both the possibilities, so conclusion II is also true.
 Therefore, both conclusions are true.

Example 4: Which of the two conclusions can be concluded on the basis of given statements?

Statements: All sides are lengths.
 No length is a breadth.

Conclusions: All lengths are sides
 No breadth is a side

Solution: Two possible diagrams are shown below for the given statements.

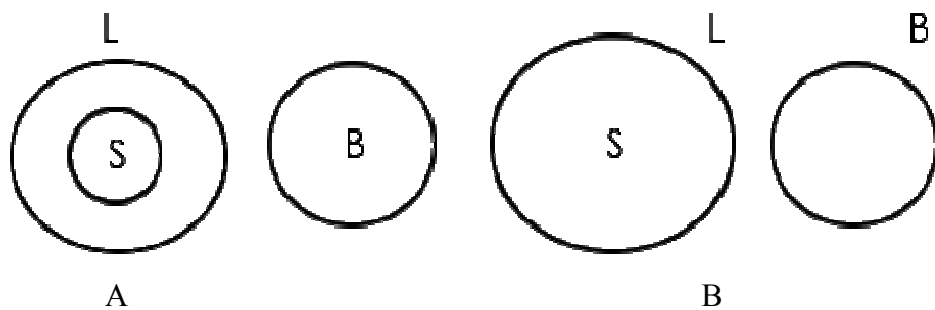

Conclusion I: False (conclusion follows from the second possibility but doesn't follow from the first possibility)

Conclusion II: True (conclusion follows from both the Venn diagram possibilities.)

Therefore, only conclusion II is true.

Q 5 - Statements: I. Some pigs are bachelors.
 II. All bachelors are blessed.

Conclusions: I. Some pigs are blessed.
 II. At least some blessed are bachelors.

- A - If only conclusion I follows.
- B - If only conclusion II follows.
- C - If either conclusion I or II follows.
- D - If neither conclusion I nor II follows.
- E - If both conclusion I and II follows.

Answer : E

Explanation

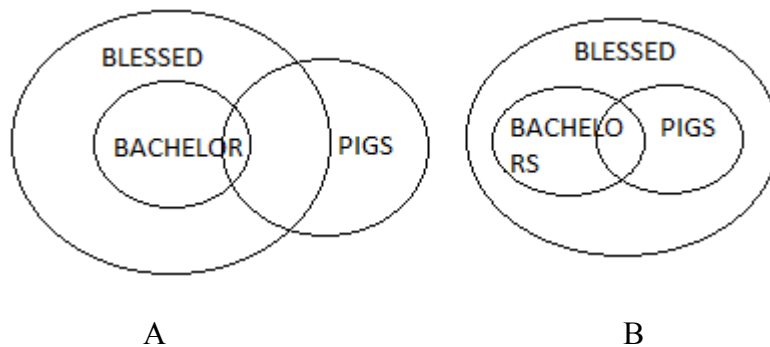

Some pigs are bachelors (I) + all bachelors are blessed (A) = I + A = I = some pigs are blessed. Hence conclusion I follows. Again all bachelors are blessed - conversion - some blessed are bachelors. Hence conclusion II also follows.

Q 6 - Statements: I. Some pictures are beds.
 II. All beds are trees.
Conclusions: I. Some pictures are trees.
 II. At least some trees are beds.

- A - If only conclusion I follows.
- B - If only conclusion II follows.
- C - If either conclusion I or II follows.
- D - If neither conclusion I nor II follows.

E - If both conclusion I and II follows.

Answer : E

Explanation:

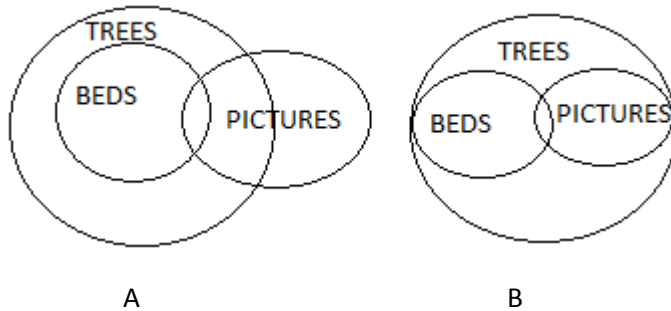

Some pictures are beds (I) + all beds are trees (A) = I + A = I = some pictures are trees. Hence conclusion I follows. Again all beds are trees - conversion - some trees are beds. Hence conclusion II also follows.

Three premise argument

A syllogism is a form of reasoning in which the conclusion is drawn from the given statements. Three Premise Arguments means that there are 3 statements and 1 or more conclusions. These are same as the two premise arguments. They are also represented in the form of Venn Diagrams.

A. Definite Conclusions

In the three premise arguments, three statements are given. These three statements can be used to draw conclusions or define possibilities. Conclusions are drawn when the statements directly lead to one of the conclusions. Below each set of statements, a set of conclusions will be given. your job is to identify the correct option. Definite conclusions are those conclusions which are definitely true from the given Premises. In the arguments, the premise is very important. The conclusions or the inference are drawn from the premise and the reasoning is entirely based on the premise.

Examples –

1. Statements: I. All A are B
II. All B are C
III. Some D is A

- Conclusions: I. All A is C.
II. All A are D
III. Some D is B

- A) I, II and III are correct
- B) Only I and II are correct
- C) Only II and III are correct
- D) Only I and III are correct

Answer- We can solve this question similarly as we used to solve the Questions of 2 Premises by using the Venn Diagrams. We can use the Venn Diagrams to easily solve this question. In fact, to solve the questions on arguments, we will have to use the Venn diagrams. Let us see below:

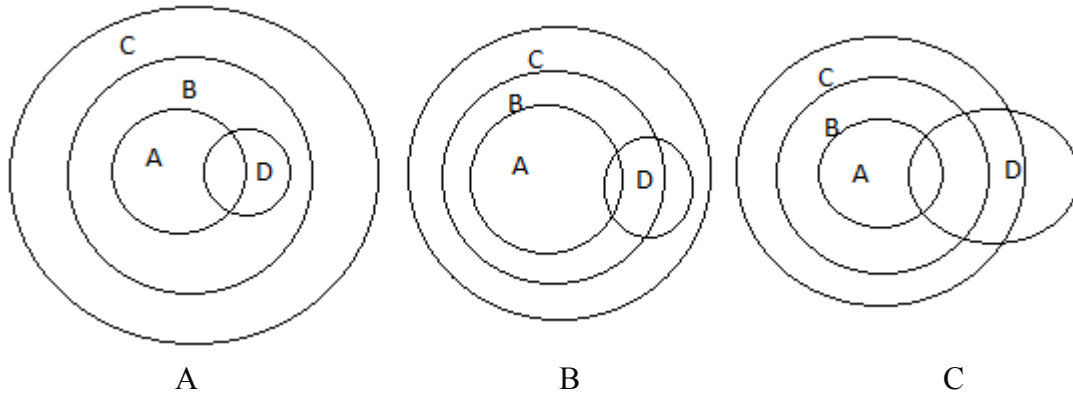

From the Venn Diagram, we can see that the conclusions I and III definitely follow.

So the correct option is D) Only I and III are correct.

Explanation: The conclusion II does not follow because in the statement it is given that Some D is A and in the conclusion, it is given that All A is D. There is some part of A about which we do not have any information so any definite conclusion about it will not follow.

B. Possibilities

Possibilities are those conclusions which are not definitely true but they may or may not be true. We can take the same example here as we saw above.

1. Statements :
- I. All A are B
 - II. All B are C
 - III. Some D are A

- Conclusions :
- I. All D are A is a possibility.
 - II. All C are A is a possibility.

- A) Both I, II are correct

- B) Only I is correct
- C) Only II is correct
- D) The data is not sufficient

Answer: We can solve this question by using the Venn diagram.

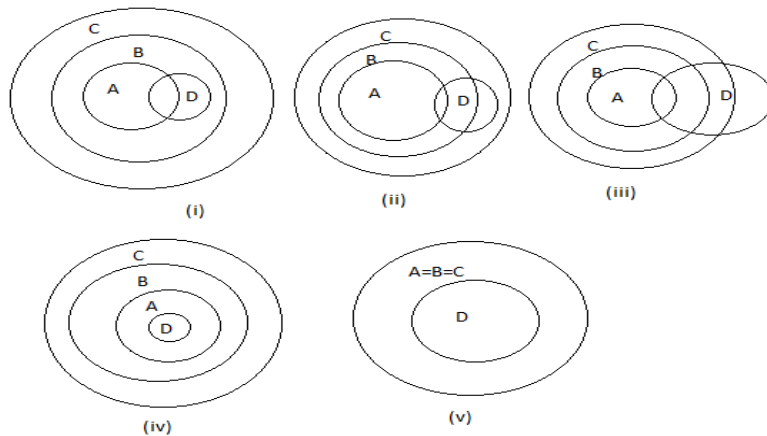

Here both the conclusions follow.

Explanation: For Conclusion I: From the above Venn diagram (iv) we can conclude that conclusion I clearly follows being a possibility.

For Conclusion II: From the above Venn diagram (iv) we can conclude that conclusion II clearly follows being a possibility.

Hence the correct option is A) Both I, II are correct.

Other Types of Questions

2. Statements :
- I. Some A is not B
 - II. Some B are C
 - III. Some D is C

- Conclusions:
- I. All A is not B is a possibility
 - II. Some B are D

Answer:- We can solve this question by the below Venn Diagram. The cross in the red designates the relation “are not”. We can say that since some A are B, not all A are B is also one possibility. The following Venn Diagram represents the statements present in the above question.

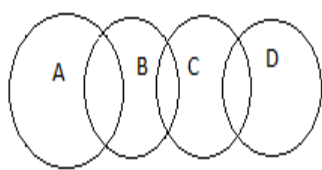

(i)

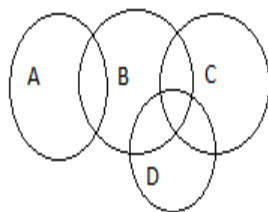

(ii)

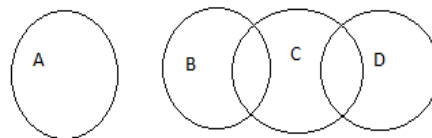

(iii)

Hence only the conclusion I follow.

Explanation: For Conclusion I: It is given that All A is not B is a possibility but in Statement I, it is given that Some A are not B.

So, from the above Venn diagram it is clear that conclusion I is correct.

For Conclusion II: It does not follow because no direct relation between B and D is given. The only relation is between C and D and between B and C. So conclusion II doesn't follow.

Questions -

1. Statements:
- I. All Teachers are Lawyers
 - II. All Lawyers are Doctors
 - III. All Doctors are Engineers

- Conclusions:
- I. Some Engineers are Lawyers
 - II. Some Doctors are Teachers

- A) Both are the wrong
- B) Both are correct
- C) They may be correct
- D) Data Insufficient

Ans:

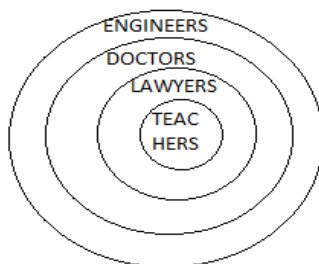

B) Both are correct

2. Statements: I. Some Trains are not Cars
II. Some Cars are Bikes
III. Some Scooters are Bikes

- Conclusions: I. All Trains are not Cars a possibility.
II. Some Scooters are Cars.

- A) Both are the wrong
B) Both are correct
C) I is correct
D) II is correct

Ans:

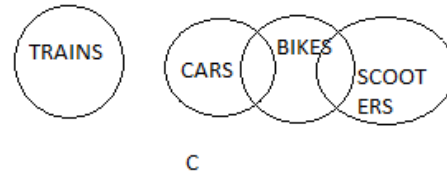
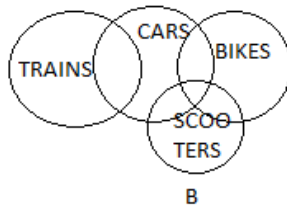
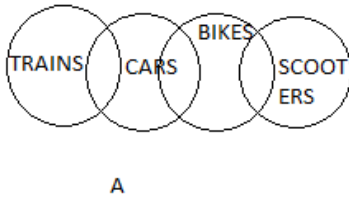

C) I is correct.

UNIT -3: Venn Diagrams, Mirror Images, Problems on Cubes and Dices

VENN DIAGRAMS

It is a process of showing complex relationship between 2-3 categories diagrammatically through various geometric structures. Intersection between two geometric structures indicate that they have something in common and total isolation indicates just opposite of that.

Venn diagram, also known as Euler-Venn diagram is a simple representation of sets by diagrams. The usual depiction makes use of a rectangle as the universal set and circles for the sets under consideration.

(a) Venn Diagram in case of two elements

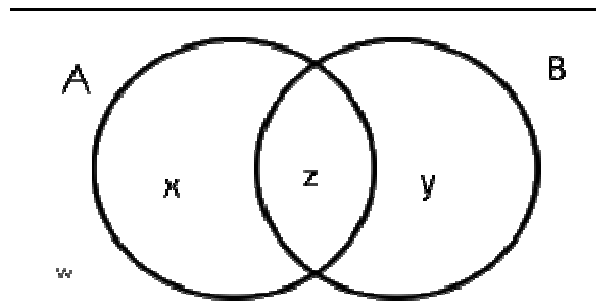

Where;

X = number of elements that belong to set A only

Y = number of elements that belong to set B only

Z = number of elements that belong to set A and B both ($A \cap B$)

W = number of elements that belong to none of the sets A or B

From the above figure, it is clear that

$$n(A) = x + z ;$$

$$n(B) = y + z ;$$

$$n(A \cap B) = z ;$$

$$n(A \cup B) = x + y + z.$$

$$\text{Total number of elements} = x + y + z + w$$

Venn Diagram in case of three elements

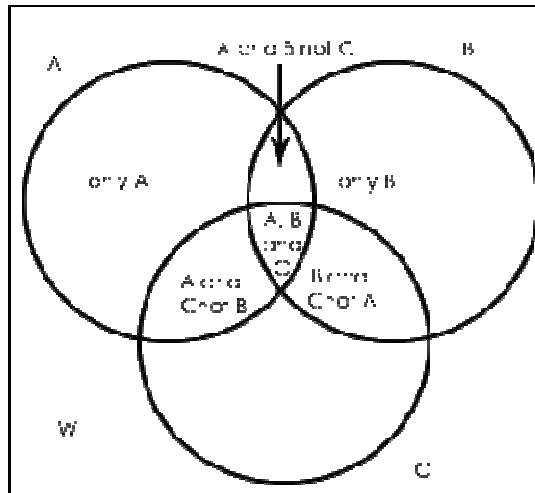

Where,



W = number of elements that belong to none of the sets A, B or C



Let's take a look at some basic formulas for Venn diagrams of two and three elements.

$$n(A \cup B) = n(A) + n(B) - n(A \cap B)$$

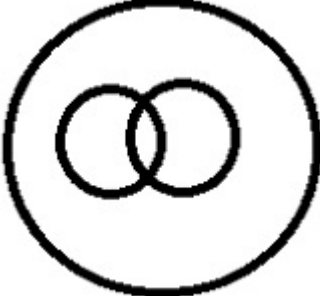
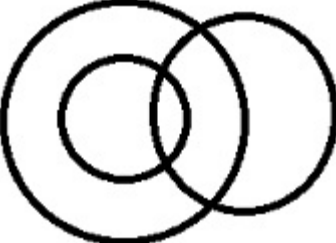
$$n(A \cup B \cup C) = n(A) + n(B) + n(C) - n(A \cap B) - n(B \cap C) - n(C \cap A) + n(A \cap B \cap C)$$

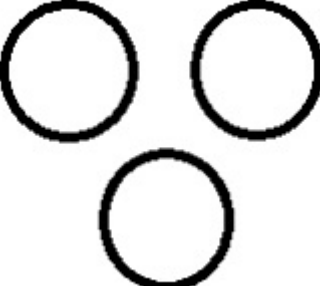
Venn diagram	Applicable cases	Example
	<p>There will be a series of sub cases one under another.</p>	<p>Colour >Green>light green. Light green colour is a sub part of green colour and both of them belongs to colour group.</p>

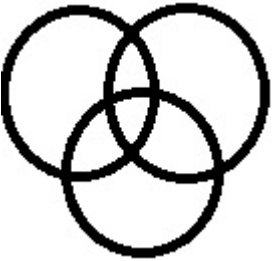
	<p>One main category, under it two sub categories and both bear some similarities among them.</p>	<p>Liquids>Petrol, Car fuel. Here both are flammables in nature, thus bear similarity.</p>
	<p>One category may have one sub category. They both partially satisfy some conditions (not always).</p>	<p>Vegetable>Capsicum>Red. Some capsicums are red and so as some other vegetables.</p>
	<p>Among three different sections, two may have some common properties those do not match with third one.</p>	<p>Actor>Headmaster>Queen. From the above, actor and headmaster are showing masculinity, thus bearing some common properties which is just opposite to Queen.</p>
	<p>Three sections having no common feature.</p>	<p>Tree>Angry>Coffee. There is no logic of finding any common aspect among above three terms.</p>

	<p>There is a chance of finding a common place that satisfies all the properties of three individual sections.</p>	<p>Mother>Step mother>Sister-in law. A single woman can be all of the above said simultaneously.</p>
	<p>This is particular for those cases in which out of three sections, two are inter related as parent child relationship, whereas third one has no relation with them.</p>	<p>Tree>banana tree>Angry. We all know banana tree is coming under tree category but emotion” Angry” has nothing to do with these 2 words.</p>

Example 1:

If all the words are of different groups, then they will be shown by the diagram as given below.

Dog, Cow, Horse

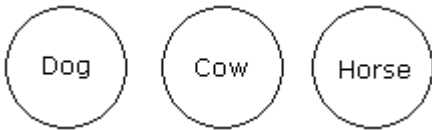

All these three are animals but of different groups, there is no relation between them. Hence they will be represented by three different circles.

Example 2:

If the first word is related to second word and second word is related to third word. Then they will be shown by diagram as given below.

Unit, Tens, Hundreds

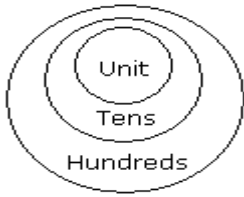

Ten units together make one Tens or in one tens, whole unit is available and ten tens together make one hundreds.

Example 3:

If two different items are completely related to third item, they will be shown as below.

Pen, Pencil, Stationery

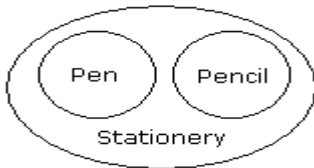

Example 4:

If there is some relation between two items and these two items are completely related to a third item they will be shown as given below.

Women, Sisters, Mothers

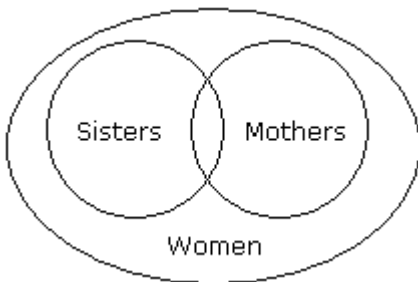

Some sisters may be mothers and vice-versa. Similarly some mothers may not be sisters and vice-versa. But all the sisters and all the mothers belong to women group.

Example 5:

Two items are related to a third item to some extent but not completely and first two items totally different.

Students, Boys, Girls



The boys and girls are different items while some boys may be students. Similarly among girls some may be students.

Example 6:

All the three items are related to one another but to some extent not completely.

Boys, Students, Athletes

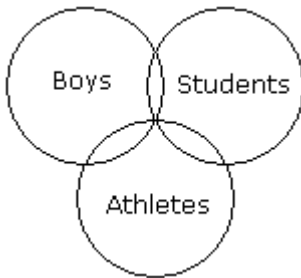

Some boys may be students and vice-versa. Similarly some boys may be athletes and vice-versa. Some students may be athletes and vice-versa.

Problems

Example-1

Which of the following diagrams indicates the best relation between Travelers, Train and Bus ?

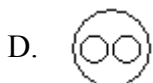
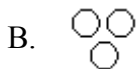

Solution- Option C

Bus and Train are different from each other but some travelers travel by bus and some travel by train.

Example 2: In a college, 200 students are randomly selected. 140 like tea, 120 like coffee and 80 like both tea and coffee.

- How many students like only tea?
- How many students like only coffee?
- How many students like neither tea nor coffee?
- How many students like only one of tea or coffee?
- How many students like at least one of the beverages?

Solution: The given information may be represented by the following Venn diagram, where T = tea and C = coffee.

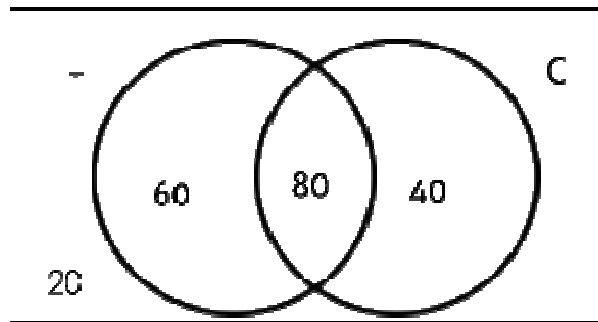

Number of students who like only tea = 60

Number of students who like only coffee = 40

Number of students who like neither tea nor coffee = 20

Number of students who like only one of tea or coffee = 60 + 40 = 100

Number of students who like at least one of tea or coffee = n (only Tea) + n (only coffee) + n (both Tea & coffee) = 60 + 40 + 80 = 180

Example 3 :

The population of a town is 10000. Out of these 5400 persons read newspaper A and 4700 read newspaper B. 1500 persons read both the newspapers. Find the number of persons who do not read either of the two papers.

Solution :

Let A = The set of persons who read newspaper A

B = The set of persons who read newspaper B

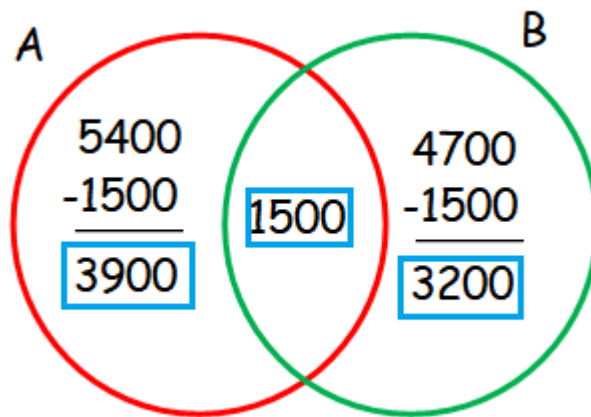

$$\begin{aligned} \text{Number of persons who read at least one news paper} &= 3900 + 1500 + 3200 \\ &= 8600 \end{aligned}$$

$$\text{Total population} = 10000$$

$$\begin{aligned} \text{To find the number of persons who do not read either of the two papers, we have to subtract} \\ \text{number of persons who read at least one from total population.} &= 10000 - 8600 \\ &= 1400 \end{aligned}$$

Hence the number of persons who do not read either of the two papers is 1400.

Example 4:

In a school, all the students play either Foot ball or Volley ball or both. 300 students play Foot ball, 270 students play Volley ball and 120 students play both games. Find

- (i) the number of students who play Foot ball only
- (ii) the number of students who play Volley ball only
- (iii) the total number of students in the school

Solution :

Let A = The set of students who play foot ball

B = The set of students who play volley ball

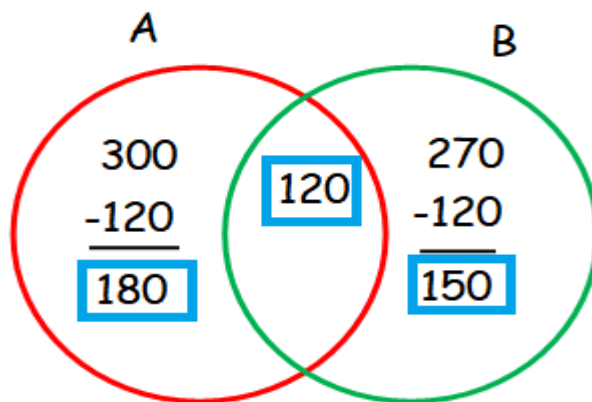

- (i) The number of students who play Foot ball only is 180
- (ii) The number of students who play Volley ball only is 150
- (iii) The total number of students in the school = $180 + 120 + 150$
 $= 450$

Example 5 :

In a School 150 students passed X Standard Examination. 95 students applied for Group I and 82 students applied for Group II in the Higher Secondary course. If 20 students applied neither of the two, how many students applied for both groups?

Solution :

A = The set of students who applied for Group I

B = The set of students who applied for Group II

$$\begin{aligned}\text{Number of students who applied at least one group} &= 150 - 20 \\ &= 130\end{aligned}$$

$$n(A) = 95, n(B) = 82 \text{ and } n(A \cup B) = 130$$

$$n(A \cup B) = n(A) + n(B) - n(A \cap B)$$

$$130 = 95 + 82 - n(A \cap B)$$

$$130 = 177 - n(A \cap B)$$

$$n(A \cap B) = 177 - 130 = 47$$

Hence the number of students applied for both groups is 47.

MIRROR IMAGE

A mirror image (in a plane mirror) is a reflected duplication of an object that appears almost identical, but is reversed in the direction perpendicular to the mirror surface. As an optical effect it results from reflection off of substances such as a mirror or water. It is also a concept in geometry and can be used as a conceptualization process for 3-D structures.

The image of an object as seen in a mirror is its mirror reflection or mirror image. In such an image, the right side of the object appears on the left side and vice versa. A mirror-image is therefore said to be laterally inverted and the phenomenon is called the lateral inversion.

Some letters don't change upon reflection. In other words, they are the same as that of their Mirror Images. The letters having identical mirror images are A, H, I, M, O, T, U, V, W, X, Y. Similarly, in small letters we have i, l, o, v, w, and x that have the same Mirror Image as that of their original images. The number 1 and 8 are the only two numbers with their identical mirror images.

The Left Hand Side (L H S) of real image becomes the Right Hand Side (R H S) in mirror image and the R H S in the real image becomes the L H S in the mirror image.

Mirror Images of Capital Letters –

Letters	Mirror-Images	Letters	Mirror-Images	Letters	Mirror-Images
A	A	J	┘	S	Ɔ
B	Ꞥ	K	Ꞥ	T	T
C	Ɔ	L	J	U	U
D	D	M	M	V	V
E	E	N	N	W	W
F	F	O	O	X	X
G	Ɔ	P	Ꞥ	Y	Y
H	H	Q	Ꞥ	Z	Ɔ
I	I	R	Ꞥ	-	-

Mirror Images of Small Letters -

Letters	Mirror-Images	Letters	Mirror-Images	Letters	Mirror-Images
a	Ꞥ	j	┘	s	Ɔ
b	d	k	Ꞥ	t	t
c	Ɔ	l	j	u	u
d	b	m	m	v	v
e	e	n	n	w	w
f	f	o	o	x	x
g	Ɔ	p	Ꞥ	y	y
h	h	q	Ꞥ	z	Ɔ
i	i	r	Ꞥ	-	-

Examples -

1. Which among the following illustrations specifies the correct mirror image of O B S T I N A T E ?

- (a) ETANIT2BO (b) BOSTINATE
(c) ETANITSBO (d) SOBTNIATE

Solution-

The first step is to check the first and the last letters. We know that the reflection at a mirror is equivalent to an inversion. In other words, we say that in a mirror top and bottom of an image doesn't change but the Left Hand Side (L H S) of real image becomes the Right Hand Side (R H S) in mirror image and the R H S in the real image becomes the L H S in the mirror image. So, (a) is the correct option.

2. Which among the following illustrations specifies the correct mirror image of P R O C R A S T I N A T E ?

- (a) ETANITSARCORP (b) ETANIT2ARCORP
(c) RPORCASTNITAE (d) ETPROCRASTINA

Answer: Let us see the first letter in the mirror image of P R O C R A S T I N A T E.

The first letter in the mirror image would be the last letter in the original word P R O C R A S T I N A T E, which is E. The only option that has its first letter as the mirror image of E is option (b). Therefore (b) is the correct option.

3. Choose the alternative which is closely resembles the mirror image of the given combination.

MALAYALAM

- (1) MALAYALAM (2) MAJAYAJAM
(3) MΛΛAYΛΛAM (4) MAΓAYAGAM

Ans : (2)

MIRROR IMAGES OF NUMBERS

Numbers	Mirror Images
1	1
2	2
3	ε
4	4
5	2
6	o
7	7
8	8
9	9

EXAMPLES -

1. Choose the alternative which is closely resembles the mirror image of the given combination.

247596
 (1) 695742 (2) 982742
 (3) 247596 (4) 982742

Ans. (4)

2. Choose the alternative which is closely resembles the mirror image of the given combination.

BR4AQ16HI
 (1) IH91QA4RB (2) |H61QA4RB
 (3) IH91QA4RB (4) IH91QA4RB

Ans (1)

3. Choose the alternative which is closely resembles the mirror image of the given combination.

qutubgarh
 (1) putudgarh (2) dnfnprgip
 (3) hragbutuq (4) nrsqdufup

Ans. (4)

4. Choose the alternative which is closely resembles the mirror image of the given combination.

Nu56p7uR
 (1) Nu20q7uR (2) Rn7q02uH
 (3) Ru7q02uH (4) Nu2p7uR

Ans. (3)

5. Choose the alternative which is closely resembles the mirror image of the given combination.

ANS43Q12
 (1) AN243Q12 (2) 210242NA
 (3) 2NA43Q12 (4) 12043ANS

Ans. (2)

MIRROR IMAGES OF FIGURES

1. Choose the correct mirror image of the given figure (X) from amongst the four alternatives.

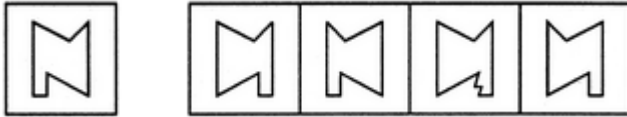

(X) (1) (2) (3) (4)

Ans. (4)

2. Choose the correct mirror image of the given figure (X) from amongst the four alternatives.



(X) (1) (2) (3) (4)

Ans. (4)

3. Choose the correct mirror image of the given figure (X) from amongst the four alternatives.

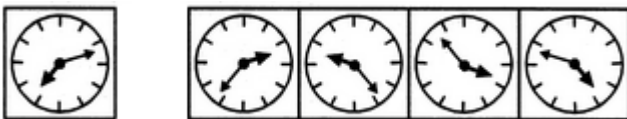

(X) (1) (2) (3) (4)

Ans. (4)

4. Choose the correct mirror image of the given figure (X) from amongst the four alternatives.

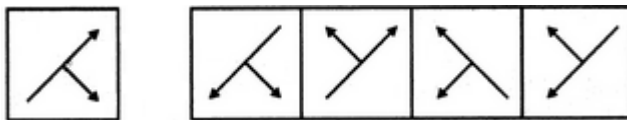

(X) (1) (2) (3) (4)

Ans. (3)

5. Choose the correct mirror image of the given figure (X) from amongst the four alternatives.

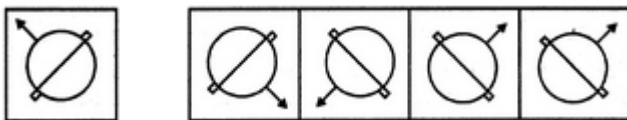

(X) (1) (2) (3) (4)

Ans. (3)

6. Choose the correct mirror image of the given figure (X) from amongst the four alternatives.

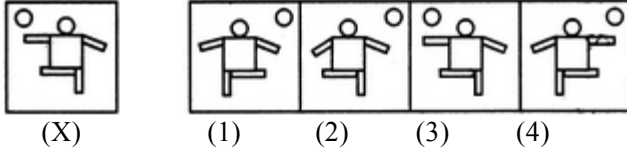

Ans. (4)

PROBLEMS ON CUBES AND DICES

CUBES

Let's first learn some basic terminologies i.e. face, vertex and edge of a cube.

In a cube, there are 6 faces, 8 vertices & 12 edges. Vertex means corners & edge means side.

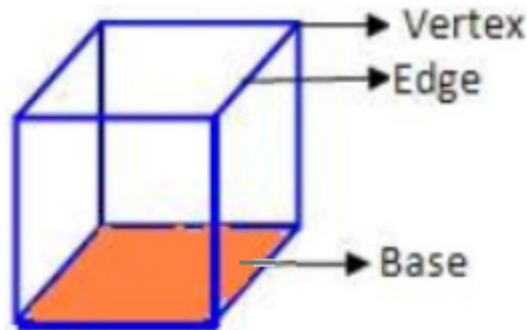

Generally, questions from this topic are of the type wherein, a cube with side measuring unit 'x' is painted on all faces and is cut into smaller cubes with sides measuring unit 'y'. You are then required to find the number of cubes having 'n' faces painted.

The first thing that you need to figure out is the number of smaller cubes. For this, you look at one particular edge of the big cube and figure out how many smaller cubes can fit into this. It will be $\frac{x}{y}$. So, the number of smaller cubes will be $\left(\frac{x}{y}\right)^3$

Since all the smaller cubes will have at least one face facing inside i.e. not on the surface of the original cube, hence, none of the smaller cubes will have all faces painted. Further, since the maximum number of faces of the larger cube that intersect at a point are 3(at the corners), hence, the smaller cubes can have a maximum of 3 faces painted.

So, the number of smaller cubes with 3 faces painted = No of corners of larger cube = 8 (always), provided none of the faces of the larger cube is left unpainted.

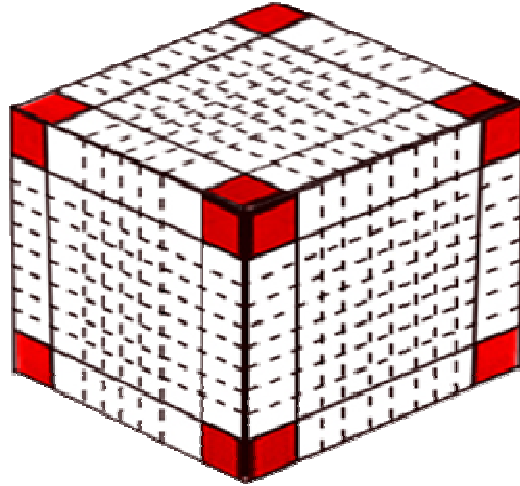

Cube Sample Questions

Example 1: A cube having a side of 6 cm is painted red on all the faces and then cut into smaller cubes of 1 cm each. Find the total number of smaller cubes so obtained.

Solution:

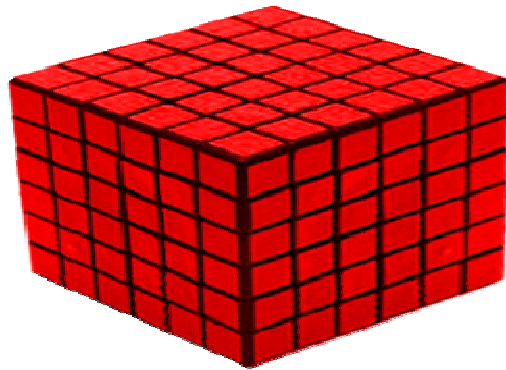

As explained above, the number of smaller cubes = $\binom{6}{1}^3 = 216$ smaller cubes.

(Here $x=6$ and $y=1$)

Example 2: In the above example, how many cubes will have three faces painted?

Solution: As explained above, only the corner cubes i.e. the 8 cubes at the corners of the original cube will have three faces painted. Hence the answer will be 8 only. To find the number of smaller cubes with only 2 faces painted, you need to consider the cubes where 2 faces of the bigger cube

meet, i.e. the edges. Remember, this includes the cubes present at the corners as well, so you need to remove those 2 cubes from the number of cubes on each edge.

Example 3: In the above example, how many cubes will have only two faces painted?

Solution: As discussed above, only the cubes at the edge of the bigger cube can have two faces painted. The larger cube has 6 cm edge and smaller cube is 1 cm edge. Hence, there are 6 cubes on each edge. However, you need to consider 4 middle cubes only, as the 2 cubes on each corner will have 3 painted faces. Hence, there are 4 such cubes on each edge. As there are 12 edges, there will be $4 \times 12 = 48$ cubes

Example 4: In the above example, how many cubes will have only one face and no side painted?

Solution: As discussed above, only the cubes at the face of the bigger cube can have only one painted face. Since the larger cube has 6 cm edge and smaller cube is 1 cm edge, hence, if you see one of the faces of the larger cube, you will see $6 \times 6 = 36$ cubes. Out of these, exclude the cubes which lie on the edges, as they have two or more faces which are painted. Thus, on each face of the original cube, there will be $4 \times 4 = 16$ cubes will have only one face painted.

As there are 6 such faces, the number of such smaller cubes will be $16 \times 6 = 96$.

Lastly, the number of cubes having no faces painted can be found by subtracting the sum of the painted cubes from the total number of smaller cubes. Therefore, the required answer is $216 - (8 + 48 + 96) = 64$ cubes.

Example 5: A cube having an edge of 12 cm each. It is painted red on two opposite faces, blue on one other pair of opposite faces, black on one more face and one face is left unpainted. Then it is cut into smaller cubes of 1 cm each. Answer the following questions:

- The total no. of smaller cubes/
- The no. of smaller cubes which are having three-faces painted.
- The no. of smaller cubes which are having two-faces painted.
- The no. of smaller cubes which are having one-face painted.
- The no. of smaller cubes which are having zero-face painted.

Solution:

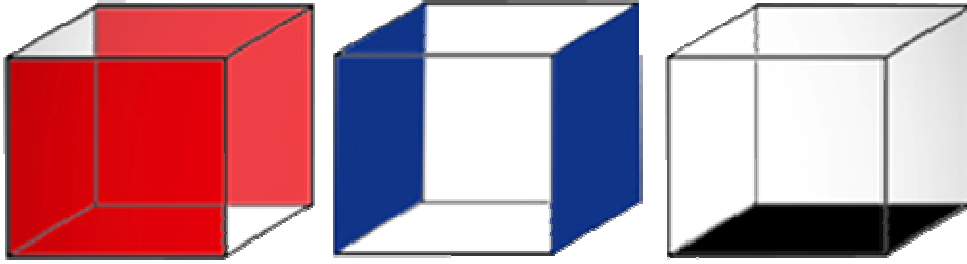

- Total number of cubes = $(12 \times 12 \times 12) / (1 \times 1 \times 1) = 1728$
- For a cube with all sides painted we have 8 cubes with 3 sides colored. But here we have 1 side unpainted. Therefore, we will have only 4 cubes with 3 sides painted. The other 4 cubes will have only 2 sides painted.

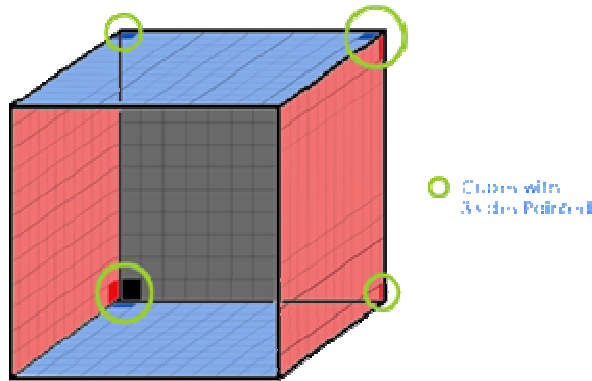

- For 2 sides painted, we look for the edges.
A cube has 12 edges.
8 edges, each edge having 10 cubes will have 2 sides painted. (4 edges of an unpainted side won't be included).
We'll also include those 4 cubes (which we didn't count while counting 3 coloured sides, as they have 2 sides painted)
Cubes on 4 edges of the unpainted side of the cube will have 1 side painted (due to the unpainted side).
Therefore, total cubes with 2 sides painted = $8 \times 10 + 4 = 84$ cubes.
- For 1 side painted, we look for the faces of the cube.
A cube has 6 faces.
5 faces each having $(12 - 2) \times (12 - 2) = 100$ cubes will have one side painted.
We'll have to include those cubes on the edges linked with an unpainted face.

10 cubes on each of those edges will have 1 side painted.

Therefore, total cubes with 1 side painted = $5 \times 100 + 4 \times 10 = 540$ cubes.

- According to the formula, cubes with no side painted = $((12 - 2)^3) = 1000$.

But we have to include the cubes from the unpainted side too. It will be $10 \times 10 = 100$

So, total number of unpainted cubes = $1000 + 100 = 1100$.

Shortcut Formulae

- For a cube of side $n \times n \times n$ painted on all sides which is uniformly cut into smaller cubes of dimension $1 \times 1 \times 1$,
- Number of cubes with 0 side painted = $(n - 2)^3$
- Number of cubes with 1 sides painted = $6(n - 2)^2$
- Number of cubes with 2 sides painted = $12(n - 2)$
- Number of cubes with 3 sides painted = 8 (**always**)

DICE

A Dice is a cube. In a cube, there are six faces.

The six faces in the cube are– ABCG, GCDE, DEFH, BCDH, AGEF and ABHF.

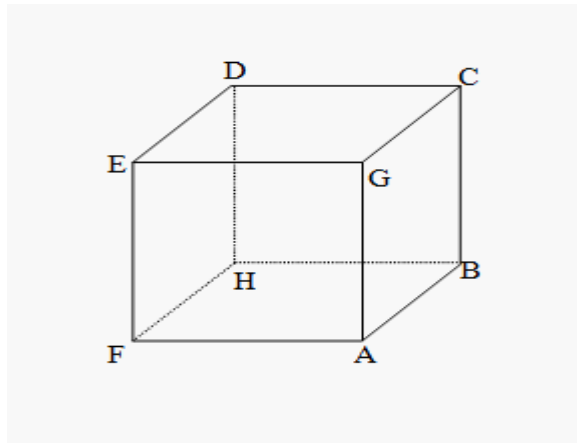

1. Four faces are adjacent to one face
2. There are pairs of opposing faces e.g. Opposite of DEFH is ABCG and so on
3. CDEG is the upper face of the cube
4. ABHF is the bottom face of the cube

Important Facts:

1. A cube has 6 square faces or sides

2. A cube has 8 points (vertices)
3. A cube has 12 edges
4. Only 3 sides of a cube are visible at a time (known as “Joint Sides”) and these sides can never be on the opposite side of each other
5. Things that are shaped like a cube are often referred to as ‘cubic’
6. Most dice are cube shaped, with the numbers 1 to 6 on the different faces.

Certain Basic Rules:

There are certain dice rules in reasoning which can be used to solve dice-based questions:

Rule No. 1:

Two opposite faces of the dice cannot be adjacent to each other.

E.g. Two positions of a dice are shown below.

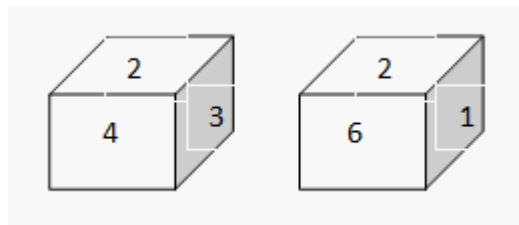

Here, faces with number 4, 3, 6 and 1 are adjacent to the face number 2.

Therefore, the 4,3,6,1 can't be opposite to the face number 2.

Therefore, face number 5 is opposite to the face number 2.

Rule No. 2:

If two dice are shown as below, and one of the two common faces (Face number 4) is in the same position, then the remaining faces will be opposite to each other.

E.g.: Two dice are shown below.

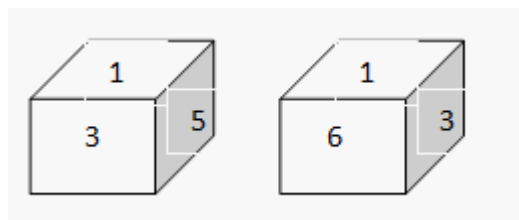

In both the diagrams, two faces numbered 1 & 3 are common.

Also, 5 & 6 are remaining faces. Hence, face which is number 5 is opposite to the face number 6.

Rule No. 3:

If in 2 different positions of the dice, the positions (different), the position of the face that's common is the same, and then the opposite faces of the faces that remain will be in the same positions.

E.g.:

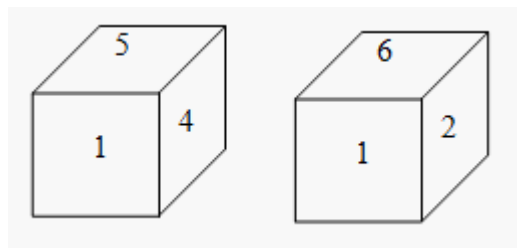

In both the positions, face number 1 is common for both dice is same. Therefore, the opposite of 4 is 2 and the opposite of 5 is 6.

Rule No. 4:

If 2 positions of a die are given (Different) and it is also stated that common face is different then the face opposite to the given common face would be that which is not shown on any given face in the 2 given positions. It is also to be noted that the opposite face of the faces that are left cannot be the same.

E.g.:

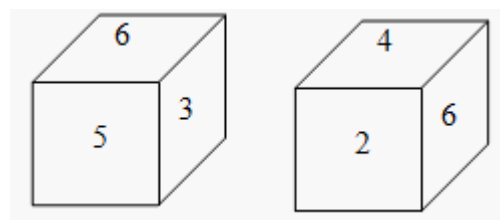

Note, in the above shown dice, the face having value 6 is not in the similar position. The face numbered 1 is not shown. So, the face opposite to the face with number 6 is 1. Also, the opposite face of 3 is the face with number 2 and the opposite to face numbered 5 is the face with number 4.

Now that you know the basic concepts on cubes and dice reasoning tricks. Let us study a few solved examples on dice reasoning

Dice Sample Questions –

1. Which symbol will be on the face opposite to the face with symbol * ?

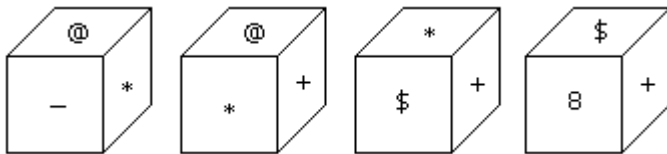

- A. @
- B. \$
- C. 8
- D. +

Answer : Option C

Explanation: The symbols of the adjacent faces to the face with symbol * are @, -, + and \$. Hence the required symbol is 8.

2. Two positions of dice are shown below. How many points will appear on the opposite to the face containing 5 points?

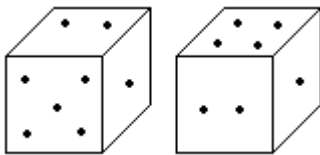

- A. 3
- B. 1
- C. 2

D. 4

Answer : Option **D**

Explanation: In these two positions one of the common face having 1 point is in the same position. Therefore according to rule (2), there will be 4 points on the required face.

3. Which digit will appear on the face opposite to the face with number 4?

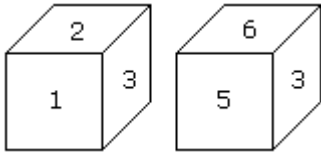

A. 3

B. 5

C. 6

D. 2/3

Answer : Option **A**

Explanation : Here the common faces with number 3, are in same positions. Hence 6 is opposite to 2 and 5 is opposite to 1. Therefore 4 is opposite to 3.

4. Two positions of a dice are shown below. Which number will appear on the face opposite to the face with the number 5?

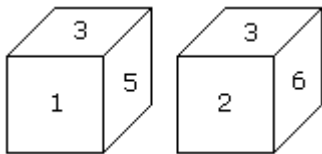

A. 2/6

B. 2

C. 6

D. 4

Answer : Option C

Explanation: According to the rule no. (3), common faces with number 3, are in same positions. Hence the number of the opposite face to face with number 5 will be 6.

5. How many points will be on the face opposite to in face which contains 2 points?

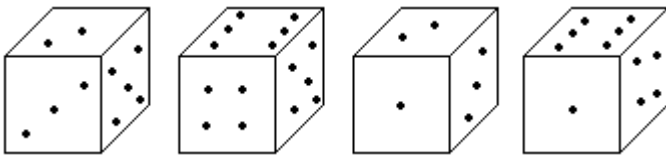

A. 1

B. 5

C. 4

D. 6

Answer : Option D

Explanation:

In first two positions of dice one common face containing 5 is same. Therefore according to rule no. (3) the face opposite to the face which contains 2 point, will contains 6 points.